



Instruction Manual

Toftejorg™ SaniJet™ 20 Media Driven

Versions included:

- Standard
- Hastelloy
- Q-doc - Equipment Doc (3.1 Inspection Certificate - EN 10204)
- Q-doc - Qualification Doc (Qualification Documentation, FAT/SAT)
- ATEX Certification in accordance with Directive 94/9/EC
- Improved surface finish (0.5 µm Ra internal/external media contact parts)

IM-TE91A792-EN9

ESE01819EN

Date of issue: April 1, 2014

First published: July 2000

Original manual

Instruction Manual

Contents

Contents	1
Toftejorg SaniJet 20 Media Driven, Product program	3
Media Driven: Toftejorg SaniJet 20 (4" connection)	3
Media Driven: Toftejorg SaniJet 20 (3" connection)	3
Accessories.....	4
Introduction	5
Intended Use	6
Patents and trademarks	6
ATEX Marking.....	6
General Description.....	7
Quality System	7
Functioning	8
Media driven Drive unit	9
Self-cleaning	10
Cleaning Pattern, The Golden Section.....	10
Technical Data.....	11
Performance Data for Toftejorg SaniJet 20 Media Driven.....	11

Instruction Manual - Installation

Contents	15
General Installation Instructions.....	17
Special Conditions for Safe Use in accordance with the ATEX Certification, Directive 94/9/EC.....	18

Instruction Manual - Operation

Contents	19
Normal Operation.....	21
Safety Precautions.....	23

Instruction Manual - Maintenance

Contents	25
Maintenance	27
Preventive Maintenance	27
Reserved rights for design changes of Alfa Laval equipment used in validated processes	27
Service and repair of ATEX approved machines	28
Service and repair of machines ordered with Q-Doc.....	29

Part List Drawing	31
Toftejorg SaniJet 20 Media Driven complete, Part List Drawing	31
Reference Lists of Parts	32
Toftejorg SaniJet 20, Media Driven (EPDM as standard)	32
Toftejorg SaniJet 20 media driven with improved surface finish (EPDM as standard)	34
Toftejorg SaniJet 20 media driven, Hastelloy version (FFKM as standard)	36
Toftejorg SaniJet 20 media driven, Hastelloy version (FFKM as standard)	37
Available add-on´s for Spare parts.....	39
Maintenance	40
Dismantling and reassembling, Turbine Unit	40
Dismantling and reassembling, Cleaner Unit	41
Dismantling and reassembling, Base Unit	42
Rotacheck System.....	43
Trouble Shooting Guide.....	44
Service Kits and Tools.....	46
Service Intervals	46
Service Kit in EPDM for Toftejorg SaniJet 20 media driven version.....	46
Service Kit in FPM (Viton) for Toftejorg SaniJet 20 media driven version.....	46
Service Kit in FFKM (Perlast) for Toftejorg SaniJet 20 media driven version.....	47
Minor Service Kit for Toftejorg SaniJet 20 media driven version.....	47
Tools	47
How to Order Spare Parts	48
How to contact Alfa Laval Tank Equipment.....	48
EU Declaration of Conformity with ATEX Certification	49
Declaration of Conformity per EN 10204 Type 2.2	50

Toftejorg SaniJet 20 Media Driven, Product program

This manual covers the product programme for Toftejorg SaniJet 20 Media Driven. For information on the air driven and electric driven versions, please refer to Instruction Manual IM-TE91A793 for the air driven version and IM-TE91A794 for the electrically driven version.

Media Driven: Toftejorg SaniJet 20 (4" connection)

	Standard		Improved surface finish*		Hastelloy C22 (FFKM as standard)	
Length	2xø3.8mm	4xø4.2mm	2xø3.8mm	4xø4.2mm	2xø3.8mm	4xø4.2mm
500mm	TE24G040	TE24G060	TE24F040	TE24F060	TE24H040	TE24H060
350mm	TE24G041	TE24G061	TE24F041	TE24F061	TE24H041	TE24H061
700mm	TE24G042	TE24G062	TE24F042	TE24F062	TE24H042	TE24H062
1000mm	TE24G044	TE24G064	TE24F044	TE24F064	TE24H044	TE24H064
1200mm	TE24G046	TE24G066	TE24F046	TE24F066	TE24H046	TE24H066
1500mm	TE24G048	TE24G068	TE24F048	TE24F068	TE24H048	TE24H068

Media Driven: Toftejorg SaniJet 20 (3" connection)

	Standard		Improved surface finish*		Hastelloy C22 (FFKM as standard)	
Length	2xø3.8mm	4xø4.2mm	2xø3.8mm	4xø4.2mm	2xø3.8mm	4xø4.2mm
500mm	TE24B040	TE24B060	TE24E040	TE24E060	TE24C040	TE24C060
350mm	TE24B041	TE24B061	TE24E041	TE24E061	TE24C041	TE24C061
700mm	TE24B042	TE24B062	TE24E042	TE24E062	TE24C042	TE24C062
1000mm	TE24B044	TE24B064	TE24E044	TE24E064	TE24C044	TE24C064
1200mm	TE24B046	TE24B066	TE24E046	TE24E066	TE24C046	TE24C066
1500mm	TE24B048	TE24B068	TE24E048	TE24E068	TE24C048	TE24C068

* Surface finish: 0.5 µm Ra internal/external media contact parts. 0.8 µm non media contact parts. Passivated. Note: Nominal Surface Finish

The item number TE24GXXX, TE24FXXX, TE24HXXX, TE24BXXX, TE24EXXX and TE24CXXX must always be included with an add-on extension of -XX.

Available add-on's

For TE24GXXX, TE24FXXX, TE24BXXX and TE24EXXX	For TE24HXXX and TE24CXXX
-0X (Standard)	-0X (Standard)
-5X Qualification Doc	-5X Qualification Doc
-6X Qualification Doc + ATEX	-6X Qualification Doc + ATEX
-7X ATEX	-7X ATEX
-8X Equipment Doc + ATEX	-8X Equipment Doc + ATEX
-9X Equipment Doc	-9X Equipment Doc
-X0 EPDM (Standard)	-X4 FFKM (Standard)
-X1 FPM (Viton)	
-X4 FFKM	

Toftejorg SaniJet 20 Media Driven, Product program

Explanation to Add-on's:

Equipment Doc includes:



- Declaration of Compliance:
- EN 10204 type 3.1 inspection Certificate
 - FDA Declaration of Compliance
 - USP Class VI (if possible)
 - TSE Declaration
 - QC Declaration of Compliance

Qualification Doc includes.



- Qualification Documentation:
- RS, Requirement Specification
 - DS, Design Specification incl. Traceability Matrix
 - FAT, Factory Acceptance Test incl. IQ & OQ
 - SAT, Site Acceptance Test Protocol incl. IQ & OQ for End-User Execution
 - Declaration of Compliance:
 - EN 10204 type 3.1 inspection Certificate
 - FDA Declaration of Compliance
 - USP Class VI (if possible)
 - TSE Declaration
 - QC Declaration of Compliance

ATEX includes:

ATEX approved machine for use in explosive atmospheres. Category 1 for installation in zone 0/20 in accordance to Directive 94/9/EC. Ex II 1 GD c T140°C.

Accessories

Clamp Coupling Parts

Reference no.	Description
9611-31-019-0	Clamp welding liner 1"
9611-99-1358	Gasket EPDM f. 1" Clamp coupling
211053	Clamp ring 1"
9611-31-023-0	Clamp welding liner 3"
9611-99-1362	Gasket EPDM f. 3" Clamp coupling
211056	Clamp ring 3"
9611-31-024-0	Clamp welding liner 4"
9611-99-1363	Gasket EPDM f. 4" Clamp coupling
211057	Clamp ring 4"

Monitoring

An electronic system with rotation sensor to validate 360° coverage can be included:

TE52E067 Rotacheck Sensor ø27 mm

TE52E058 Rotacheck Relay

For further information see page 43.

Introduction

This manual has been prepared as a guide for installation and for the persons who will be operating and maintaining your tank cleaning machine. The key to long life for your tank cleaning machine is a carefully planned system for preventive maintenance; you must appreciate that a tank cleaning machine which has a rough and dirty job to do will need more frequent attention than one working under ideal conditions.

Note: Get the best and most economical performance from your tank cleaning machine. Insufficient preventive maintenance means poor performance, unscheduled stops, shorter lifetime and extra costs. Good preventive maintenance on the contrary means good performance, no unscheduled stops and superior total economy.

The information in this manual is simple to follow, but should you require further assistance, our Customer Service Department and world-wide net of Distributors will be pleased to help you. Please quote the type, article and serial number with all your enquiries; this will help us to help you. The type, article and serial number are laser engraved on the Base house of the tank cleaning machine.

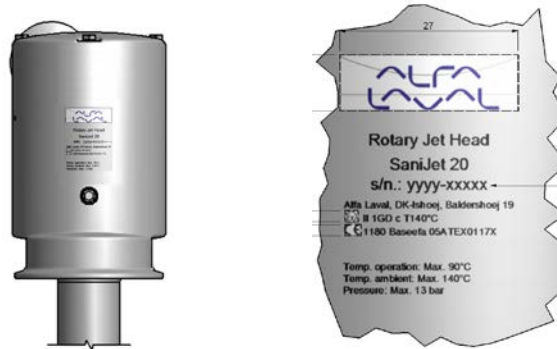

Warning: Before installing the machine and setting it into operation carefully read the General Installation Instructions (page 17) and the Safety Precautions (page 23) and take all necessary precautions according to your application and local regulations.



© Alfa Laval Corporate AB

This document and its contents is owned by Alfa Laval Corporate AB and protected by laws governing intellectual property and thereto related rights. It is the responsibility of the user of this document to comply with all applicable intellectual property laws. Without limiting any rights related to this document, no part of this document may be copied, reproduced or transmitted in any form or by any means (electronic, mechanical, photocopying, recording, or otherwise), or for any purpose, without the expressed permission of Alfa Laval Corporate AB. Alfa Laval Corporate AB will enforce its rights related to this document to the fullest extent of the law, including the seeking of criminal prosecution.

Intended Use

It is to be verified by the end-user:

- that the tank cleaning machine is in conformity with respect to tank, vessel or container size in which it will be used.
- that the construction materials (both metallic and non-metallic) are compatibility with product, flushing media, cleaning media, temperatures and pressure under the intended use.

Patents and trademarks

This Instruction Manual is published by Alfa Laval Kolding A/S without any warranty. Improvements and changes to this Instruction Manual may at any time be made by Alfa Laval Kolding A/S without prior notice. Such changes will, however, be incorporated in new editions of this Instruction Manual.

© Alfa Laval Kolding A/S. All rights reserved.

The Alfa Laval logotype is a trademark or a registered trademark of Alfa Laval Corporate AB. "Toftejorg" and "SaniJet" are trademarks or registered trademarks of Alfa Laval Kolding A/S. The Toftejorg™ SaniJet™ 20 product has patents in the EPO member states, in the US and in other countries. Other products or company names mentioned herein may be the trademarks of their respective owners. Any rights not expressly granted herein are reserved.

ATEX Marking

The Toftejorg SaniJet 20 is certified as category I component. The certification is carried out by the certified body Baseefa, who has issued the certificate no. 05ATEX0117X. The marking on the ATEX certified Toftejorg SaniJet 20 is as follows:

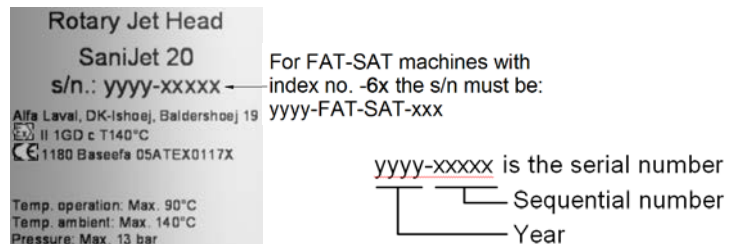

Changes to the machine are not allowed without approval by the person responsible for the ATEX certification at Alfa Laval Tank Equipment A/S. If changes are made – or spare parts other than Alfa Laval original spare parts are used - the EC Type Examination certification (the ATEX Directive) is no longer valid.

Important information:

Also see "Maintenance" pages 28 ff regarding special conditions for repair of ATEX certified machines.



General Description

The Toftejorg SaniJet 20 is a tank cleaning machine intended for industrial use in closed tanks for processing storage and transportation. There is a broad range of application areas within pharmaceutical, food and chemical industries.

The Toftejorg SaniJet 20 is a sanitary cleaning device of the rotary jet head type for permanent installation that provides a 360° indexed cleaning pattern. Provided it is installed in an upright position, the Toftejorg SaniJet 20 is completely self-cleaning and self-draining, and it has an integrated self-cleaning down pipe (patent pending). The drive mechanism is located outside the tank or process equipment, leaving a minimum of parts to be submerged into the product. All product contact surfaces are AISI 316/316L, duplex SAF 2205, Ti Grade 5, Hastelloy C22/C276 stainless steel and USP Class VI and/or FDA approved polymer materials such as PEEK, E-CTFE, EPDM, Viton and FFKM.

No threads or screws have been used in the product contact areas.

The cleaning device is lubricated by the cleaning media. No oil, grease or other lubricants are used.

The Toftejorg SaniJet 20 is available in media driven or motor driven (electrical/air) versions. The motor driven versions are equipped with a magnetic clutch providing a leakage-proof transmission and provide an effective drive for low flow machines in rough environments. The air motor has variable speed in order to adjust cleaning intensity. The air version is covered by Instruction Manual IM-TE91A793 and the electric version is covered by Instruction Manual IM-TE91A794.

The Toftejorg SaniJet 20 is designed for use in pharmaceutical, biotechnological, food and dairy processing applications. Tanks and vessels between 0.5-30 m³ (130-8,000 US gallons). The design makes the Toftejorg SaniJet 20 especially well suited when processing high viscous, foaming or thixotropic products and in chemical processing applications, where product cross contamination is unacceptable and must be avoided.

For use in explosive hazard zones the media version can be used, provided it is installed according to safety instructions in local regulations.

Quality System

The Toftejorg SaniJet 20 is produced according to Alfa Laval Tank Equipment's ISO 9001 International Standard certified quality system. All parts are made from certified material and all non-metal parts are made from FDA and USP Class VI approved materials. (Viton is, however, not USP Class VI approved).

General Description (continued)

Functioning

Toftejorg SaniJet 20 consists of 3 main parts: The Drive unit with flow inlet and the Base housing placed outside the tank, and inside the tank: the Down pipe with the rotating Outer tube and the Cleaner unit.

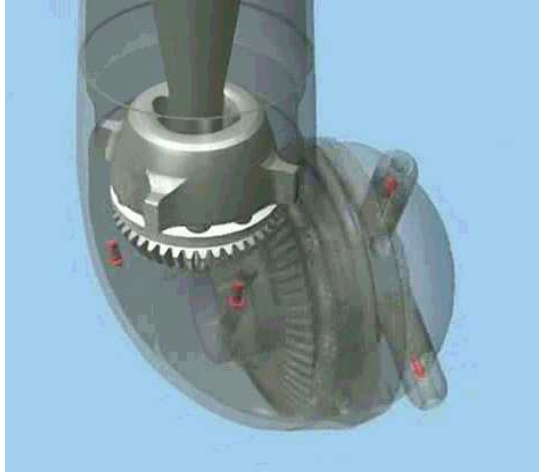

The flow of the cleaning fluid passes from the inlet through the Base housing, through the Down pipe, into the Cleaner head and out through the Nozzles. The Outer tube of the Down pipe is rotably suspended on a Stationary shaft with a Ball bearing inside the Outer tube. The Drive mechanism rotates the Outer tube with the Cleaner unit around the vertical axis. Via a set of Bevel gears on the Stationary shaft and the Cleaner head, the Cleaner head with the Nozzles is simultaneously rotated around the horizontal axis in a fixed relation thus moving the nozzles and the jets 360° around in the tank making a pre-set indexed cleaning pattern.

The Toftejorg SaniJet 20 utilises the patented “Golden Section” cleaning pattern. The distance between the tracks of the jets ensures an efficient removal of remaining product from the tank surface right from the beginning of the cleaning sequence, allowing for short cleaning time.

Example – 2 nozzle machine:

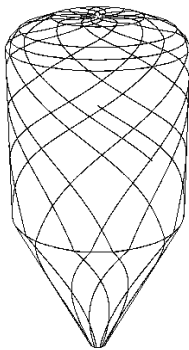

0.8 min.

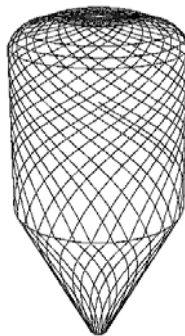

2.3 min.

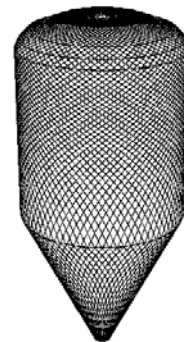

6 min.

The time needed to perform a proper cleaning depends on type of soilage, distance, cleaning procedure and agent. For substances that are easily mobilised, i.e. are easy to remove, less than 1 min. could be sufficient while in cases of more heavy soilage (high viscous, sticky substances, etc.) a more dense pattern/longer time will be needed.

General Description (continued)

Media driven Drive unit

The machine is driven by the cleaning media, which is supplied under pressure via the inlet connection. The flow enters the Inlet cap tangentially and rotates the Impeller. The velocity of the liquid determines the rotation speed of the Impeller. This depends on the actual flow rate and the size of the inlet opening. The Inlet cap is made with two different size openings.

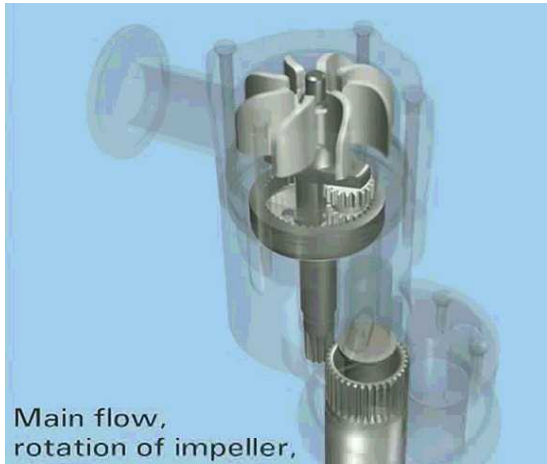

The Impeller shaft is in mesh with a Planet gear, of which the Output shaft rotates the Down pipe with the Cleaner unit.

The Planet gear is placed in the middle of the flow and thus flushed through axially while in operation, securing that all the Gear parts are thoroughly lubricated and cleaned. Bearings are designed to allow flow through the bearings for lubrication and cleaning.

General Description (continued)

Self-cleaning

Apart from the main flow flushing the inside of the Base housing and the Down pipe, and thereafter forming the jets through the Nozzles, fluid is flushed through all internal cavities, through Bevel gear, Ball bearings and gabs between moving parts and is finally also used for cleaning of the outside surfaces of the machine. From the gab between the Base housing and the rotating Down pipe, a cleaning jet is directed against the Down pipe, thus loosening and removing product remains on the outside. A liquid film flushing all around the tube further assists by continuously transporting away loosened product remains. The front of the Cleaner head is flushed by a liquid flow from the gab between the Cleaner head and the Retaining ring.

In order to ensure a proper self-cleaning, the machine must be installed in an approx. upright position and the inlet pressure must be min. 3 bar. In the bottom of the Cleaner head, in the Retaining ring, the machine is equipped with a hole to ensure self-draining. This self-draining is only ensured, if the machine is installed in an upright position.

Cleaning Pattern, The Golden Section

The patented Golden Section cleaning pattern (EP-Patent No.: 0495883. US-Patent No.: 5,279.675) is unique in building up the pattern in an ultimate uniform way. The pattern starts very coarse and refines itself in a step-less way by laying out the tracks approximately in the middle between the two most distant tracks already made. This means that the jets always clean the areas containing most remaining product, and thereby remove as much deposit as possible in the shortest possible way.

In case a complete cleaning pattern is not required, it will be possible to reach the same cleaning level within half the time and by using half the amount of cleaning fluid compared to a traditional step-wise cleaning pattern. Furthermore, due to the uniform cleaning pattern, the cleaning can be stopped at any time, whereas with traditional non-uniform cleaning pattern this would not be advantageous. However, after the complete cleaning pattern has been established, the difference between the Golden Section and the traditional stepwise cleaning pattern is negligible.

**Golden Section
Cleaning pattern**

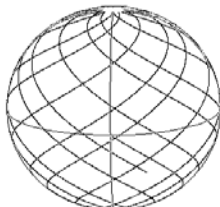

**Traditional
Cleaning pattern**

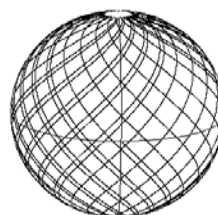
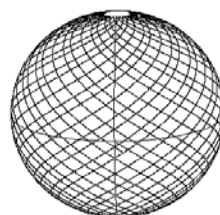
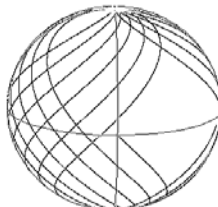

Technical Data

Performance Data for Toftejorg SaniJet 20 Media Driven

Weight of machine	: 9.5 kg (21 lbs)
Working pressure	: 3-13 bar (45-185 psi)
Recommended pressure	: 5-8 bar (73-116 psi)
Max. working temperature	: 90°C (194°F)
Max. ambient temperature	: 140°C (284°F)
Effective throw length	: 1.5-4 m (5-13 ft)
Materials	: Stainless Steel: AISI 304/316/316L, SAF 2205, Ti Grade 5, Hastelloy C22/C276, MS-nickled
	: Sealing: EPDM. FDA-approved 21 CFR §177 and USP Class VI
	: Sealing: Viton, FFKM. FDA-approved 21 CFR §177
	: Polymers: PEEK, E-CTFE. FDA-approved 21 CFR §177 and USP Class VI
Surface finish	: Product contact surfaces: Ra=0.8 µm – except weldings
Improved surface finish	: 0.5 µm Ra internal/external media contact parts - 0.8 µm Ra non media contact parts Note : Certain Exception applies
Lubricant	: Self-lubricant with the cleaning media

Principal Dimensions in mm

Inlet connection: 1" Clamp ISO2852

Tank connection: 4" Clamp ISO2852

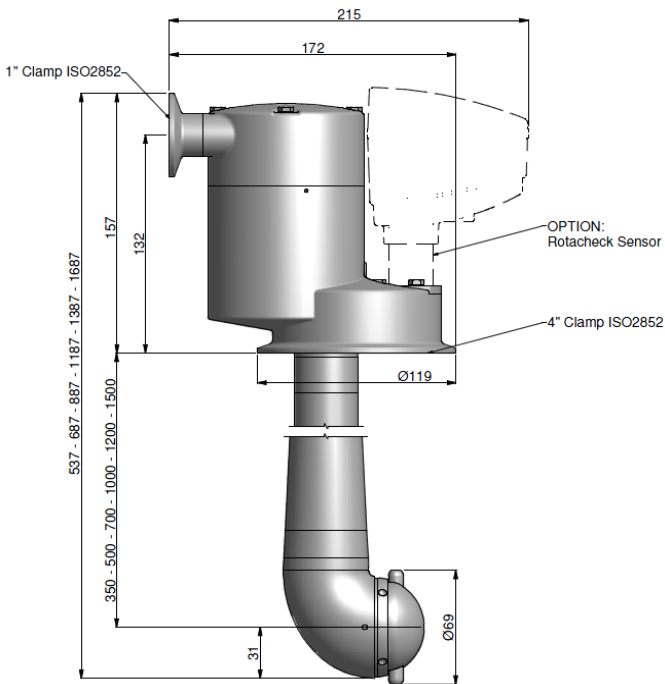

For portable or permanent installation, or installation through long "nozzles", 4" (100 mm) version are recommended.

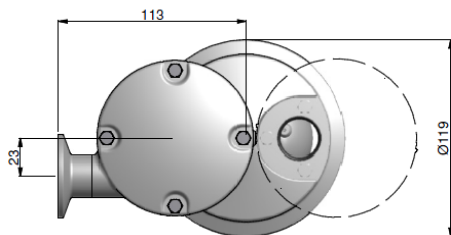
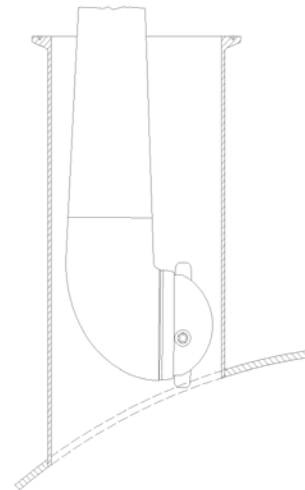

Technical Data (continued)

Principal Dimensions in mm

Inlet connection: 1" Clamp ISO2852

Tank connection: 3" Clamp ISO2852

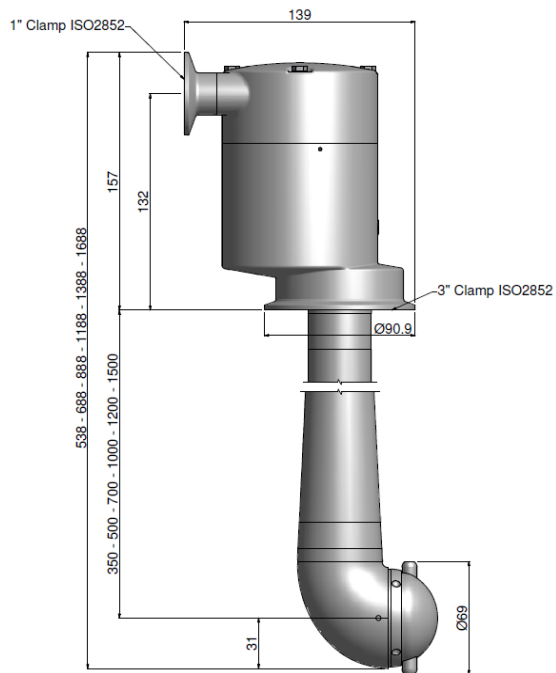

For permanent installation machine can pass through 3" clamp of max. length 50 mm:

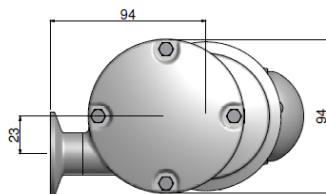
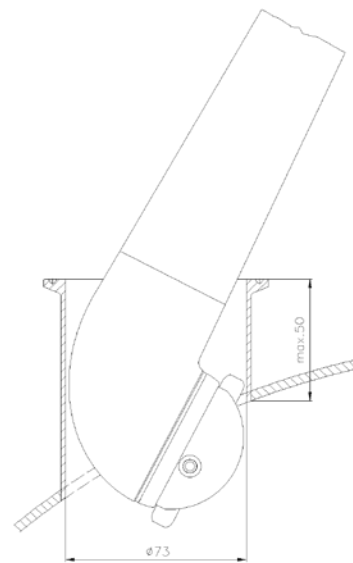

Technical Data (continued)

Performance Data for Toftejorg SaniJet 20 Media Driven

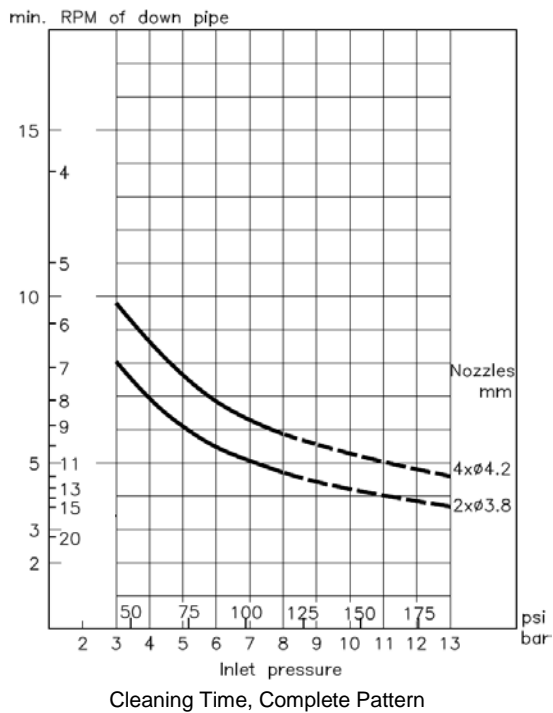
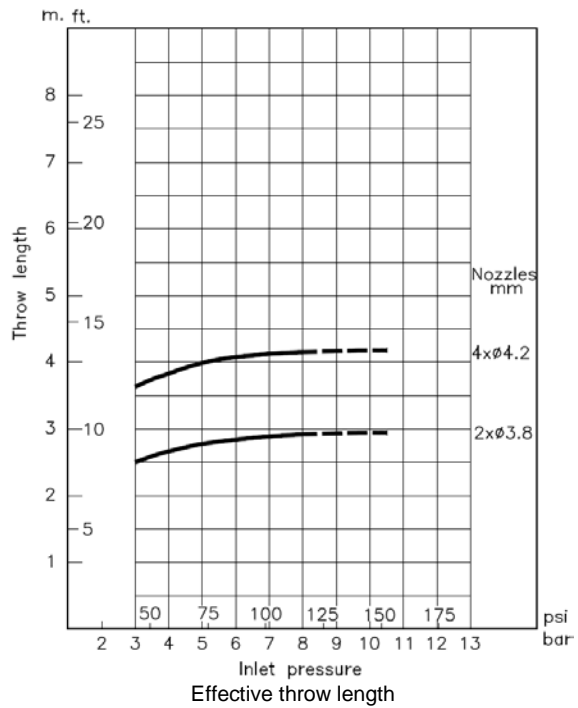
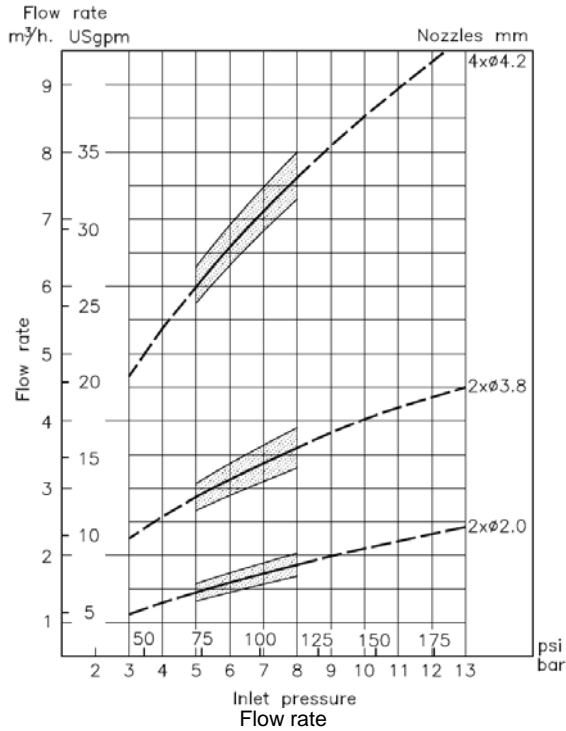

Note: Effective throw length varies depending on jet transverse speed over surface, substance to be removed, cleaning procedure and agent.

The inlet pressure has been taken immediately before the machine inlet. In order to achieve the performance indicated in the curves, the pressure drop in the supply lines between pump and machine must be taken into consideration.

- Blank page -

Instruction Manual, Installation

Contents

Contents 15
General Installation Instructions..... 17
Special Conditions for Safe Use in accordance with the ATEX Certification, Directive 94/9/EC 18

- Blank page -

Installation

General Installation Instructions

The Toftejorg SaniJet 20 is designed to be installed in a vertical upright position.

It is recommended to install a filter with mesh size 250 µm (0,01") in the supply line in order to avoid particles, scale etc. from clogging inside the machine. It is essential to avoid fine solid particles, such as fine sand, in the cleaning fluid as they will increase wear considerably. This is particular important in case of recirculation.

In order to prevent accidental leakage of cleaning fluid into the tank it is recommended to install a shut-off valve close to the machine inlet. This will also prevent back-flow of liquid from the tank through the machine in case the cleaner head is submerged and there is an over-pressure inside the tank. The installation and operation shall be made in such a way that the draining of the machine is ensured.

It is recommended that the fluid valve fitted is of a type that prevents hydraulic shocks, which may cause severe damage to the entire installation.

Before installation, all supply lines and valves must be thoroughly flushed to remove remains of welding electrodes, grinding dust, scale and other foreign matter.

During handling and installation handle the machine with care in order not to damage the fine surface finish of the machine.

The Toftejorg SaniJet 20 machine has been tested in a test tank, according to ALTQ test procedures, at the factory before shipping. For the media driven version it is advised to check if the shipping has made any damaged to the machine which may cause performance disturbance. This is done by blowing compressed air into the inlet and verify that the machine rotates evenly. If resistance is recognised, the machine should be disassembled in order to localise the cause.

Note: Do not try to turn Nozzle head by hand, since this may damage the Gear. Nozzle head can be turned by blowing air from an air pistol through the inlet connection of the media driven machine or the intake port of the air motor.

Note: The machine shall be installed in accordance with national regulations for safety and other relevant regulations and standards. In EU-countries the complete system must fulfil the EU-Machine Directive and depending of application, the EU-Pressure Equipment Directive, the EU-ATEX Directive and other relevant Directives and shall be CE-marked before it is set into operation.

Warning: Precautions shall be made to prevent starting of the cleaning operation, while personnel are inside the tank or otherwise can be hit by jets from the nozzles.



Installation (continued)

Warning: If the machine is used in potential explosive atmospheres, tapes or joint sealing compounds, which are electrical insulators, must not be used on joints, if this may violate the grounding of the machine to the tank. Resistance between nozzles and tank must not exceed 20.000 Ω . The intended installation with standard clamp connections will ensure this. In addition, connecting pipe work, must be electrically conductive and earthed to the tank structure. This is essential to avoid the build-up of static electricity on the nozzles and the machine. For further information see DS/CLC/TR 50404:2003 Safety of Machinery, guidance and recommendations for the avoidance of hazards due to static electricity.



Electrical equipment such as magnetic valves and electric actuators must not be installed in Ex-zones without type approval and marking, corresponding to the EX-class in question.

Special Conditions for Safe Use in accordance with the ATEX Certification, Directive 94/9/EC

Warning: The unit may be operated, in a hazardous area, only when completely filled with the process fluid.



Warning: The maximum permitted process fluid temperature is 90°C, with an ambient temperature range of 0°C to 140°C.



Warning: The maximum permitted process fluid pressure is 13 bar.



Warning: The unit must not be operated in a vessel having an enclosed volume of greater than 100 m³.



In addition to the above mentioned precautions relating to the ATEX guidelines Directive 94/9/EC of March 23 1994, the general safety precautions in this manual must be observed, see page 23.

Instruction Manual, Operation

Contents

Contents 19
Normal Operation 21
Safety Precautions 23

- Blank page -

Operation

Normal Operation

Pressure

In order to protect the machine, your pipe and valve installation, etc. against damage:

Avoid hydraulic shocks! Put on pressure gradually!

Recommended working pressure: 5 - 8 bar (73 - 116 psi). Too high pressure will increase consumption of wear parts.

The machine is designed to stand up to 13 bar working pressure. This is normally not recommended but may be used for special purposes, where high pressure at close distance is preferred.

ATEX Warning: If steam cleaning is done through the machine, the steam pressure must not cause the machine to rotate.



ATEX Warning: If the machine is drained using compressed air, then the compressed air pressure must not cause the machine to rotate.



Cleaning Media

Use only cleaning fluids, which are compatible with Stainless Steel AISI 316/316L, SAF2205, Titanium Grade 5, Hastelloy C22/C276, PEEK, E-CTFE, EPDM, Viton and FFKM. Please note that PEEK is not resistant to concentrated sulfuric acid. Normal detergents, moderate solutions of acids and alkalis are acceptable as well as a number of solvents at ambient temperature during cleaning. Aggressive chemicals, excessive concentrations of chemicals at elevated temperatures as well as certain solvents and hydrochlorides should be avoided. If you are in doubt, contact your local Alfa Laval Tank Equipment sales office.

Operation (continued)

Temperature

The machine is designed to operate with cleaning media at temperatures up to 90°C (194 °F). However, it stands temperatures up to 140°C (284°F) inside the tank, and it is possible to steam the tank through the machines.

The machine is not designed to rotate during steaming. A slow rotation of the media driven machine might occur and is not harmful.

Warning: Tanks with capacities greater than 100 m³ that could contain a flammable atmosphere should not be steam cleaned, as steam issuing from a nozzle could contain charged droplets.



Tanks smaller than this may be steam cleaned providing that: the steam nozzles and other metal parts of the system are reliably earthed and grounded to the tank structure.

Warning: In potentially explosive atmospheres, the temperature must not exceed the maximum surface temperature according to the temperature class for the combustible gas or liquid.



In accordance with the ATEX specifications regarding conditions for safe use, see page 18.

After-Use Cleaning

After use flush the machine with fresh water. Cleaning media should never be allowed to dry or set-up in the system due to possible "salting out" or "scaling" of the cleaning media. If cleaning media contains volatile chloride solvents, it is recommended not to flush with water after use, as this might create hydrochloric acid.

Operation (continued)

Safety Precautions

The machine is intended for use inside a tank only. As peak velocity of main jets reaches 40 m/s, Toftejorg SaniJet 20 must not be operated in open air or when tank is open.

Warning: Hot chemicals and steam under pressure may be used for cleaning and sterilising. Protect against scalding and burning. Never tamper with or try to open clamps or other connections while system is in operation. Make sure that system is de-pressurised and drained before disassembly.



The cleaning jets impinging the tank surface are a source of noise. Depending on pressure and distance to the tank walls, noise level may reach up to 85 dB.

Warning: In case potentially explosive liquids are used, precautions should be taken against incidental creation of an explosive mixture with oxygen in the tank atmosphere.



Warning: Tanks with capacities greater than 100 m³ that could contain a flammable atmosphere should not be steam cleaned, as steam issuing from a nozzle could contain charged droplets.



Tanks smaller than this may be steam cleaned providing that: the steam nozzles and other metal parts of the system are reliably earthed and grounded to the tank structure.

Warning: Tanks may contain poisonous/hazardous products or products which represent an environmental or safety risk. Never open tank and dismount the machine without checking previous tank contents and necessary precautions.



Warning: Retaining screw on side of Base housing (Pos. 17) must never be loosened, when machine is mounted in tank unless down pipe is supported and Pressure line is disconnected, as otherwise the complete Down pipe assembly will fall down.



- Blank -

Instruction Manual, Maintenance

Contents

<u>Contents</u>	25
<u>Maintenance</u>	27
<u>Preventive Maintenance</u>	27
<u>Reserved rights for design changes of Alfa Laval equipment used in validated processes</u>	27
<u>Service and repair of ATEX approved machines</u>	28
<u>Service and repair of machines ordered with Q-Doc</u>	29
<u>Part List Drawing</u>	31
<u>Toftejorg SaniJet 20 Media Driven complete, Part List Drawing</u>	31
<u>Reference Lists of Parts</u>	32
<u>Toftejorg SaniJet 20, Media Driven (EPDM as standard)</u>	32
<u>Toftejorg SaniJet 20 media driven with improved surface finish (EPDM as standard)</u>	34
<u>Toftejorg SaniJet 20 media driven, Hastelloy version (FFKM as standard)</u>	36
<u>Toftejorg SaniJet 20 media driven, Hastelloy version (FFKM as standard)</u>	37
<u>Available add-on's for Spare parts</u>	39
<u>Maintenance</u>	40
<u>Dismantling and reassembling, Turbine Unit</u>	40
<u>Dismantling and reassembling, Cleaner Unit</u>	41
<u>Dismantling and reassembling, Base Unit</u>	42
<u>Rotacheck System</u>	43
<u>Trouble Shooting Guide</u>	44
<u>Service Kits and Tools</u>	46
<u>Service Intervals</u>	46
<u>Service Kit in EPDM for Toftejorg SaniJet 20 media driven version</u>	46
<u>Service Kit in FPM (Viton) for Toftejorg SaniJet 20 media driven version</u>	46
<u>Service Kit in FFKM (Perlast) for Toftejorg SaniJet 20 media driven version</u>	47
<u>Minor Service Kit for Toftejorg SaniJet 20 media driven version</u>	47
<u>Tools</u>	47
<u>How to Order Spare Parts</u>	48
<u>How to contact Alfa Laval Tank Equipment</u>	48
<u>EU Declaration of Conformity with ATEX Certification</u>	49
<u>Declaration of Conformity per EN 10204 Type 2.2</u>	50

- Blank page -

Maintenance

Preventive Maintenance

In order to keep your tank cleaning machine servicing you as an efficient tool in your tank cleaning operations, it is essential to maintain its high performance by following a simple preventive maintenance program.

Good maintenance is careful and regular attention!

The following recommended preventive maintenance is based on tank cleaning machines working in average conditions. However, you will appreciate that a tank cleaning machine, which has a rough and dirty job to do, will need more frequent attention than one working in ideal conditions. We trust that you will adjust your maintenance program to suit.

Handle machine with care. Take proper action to protect fine surfaces from being damaged.

Always use only proper tools. Use Toftejorg SaniJet 20 standard tool kit. Never force, hammer or pry components together or apart. Always perform all assembly/disassembly steps in the order described in this manual.

Never assemble components without previous cleaning. This is especially important at all mating surfaces. Work in a clear well-lighted work area.

Reserved rights for design changes of Alfa Laval equipment used in validated processes

Alfa Laval is continuously working on improving our equipment and services. In this improvement work Alfa Laval may for example change the design and material in our equipment. A change in the design will not necessarily entail a change of the specification and item no. for the equipment.

Alfa Laval reserves the right to change the design of Alfa Laval equipment without any notifications for improvements of our design.

If Equipment from Alfa Laval is used in connection with, for example, a validated plant, and an order for replacements is made, the design of the replacement may have been changed even if the specifications /item no. is the same as the existing installed and validated ones.

When ordering a replacement please contact Alfa Laval sales support in this matter before placing the order.

Service and repair of ATEX approved machines

In order to ensure compliance with the ATEX regulations for service and repair in accordance with EN 60079-19, all service and repair of ATEX approved machines should be performed by Alfa Laval Tank Equipment, Kolding, Denmark, or by an Alfa Laval service center approved by ALTEQ.

Warning: ATEX requirements regarding repair of ATEX approved machines according to EN 60079-19.



A tag with the following labelling information must be attached to the machine:

- Repair symbol 
- Alfa Laval logo and address
- Repair number
- Date of repair
- Machine serial number

The tag must be laminated and attached to the machine using a cable tie.

If a customer wishes to carry out service or repair himself, it is the responsibility of the repair shop to ensure that the ATEX requirements are met in any way possible. After performing service or repair, the repair shop thus carries the full responsibility for the ATEX approval of the machine.

Maintenance (continued)

Service and repair of machines ordered with Q-Doc

In order to ensure full traceability and to obtain full qualification and validation documentation, all service and repair of machines ordered with Q-Doc (Qualification Documentation) should be handled and ordered in one of the 2 different ways described below:

1. **Q-Doc Service/Repair Order** (Item no.: TEREQ-Q-doc):

(This maintenance order should be selected if the customer wishes to have ALTEQ to obtain full file log of all FAT (Factory Acceptance Test) documents for the Tank Cleaning Machine).

- Maintenance/Repair is carried out at ALTEQ and Q-Doc Maintenance Log, FAT-SURFACE (if necessary), FAT-WELD (if necessary) and FAT-PERFORMANCE is performed. The FAT documents are stored in the Q-Doc Maintenance Log as PDF-files.
- 3.1 Certificate + FDA and USP Class VI Declaration of Compliance for all spare parts are stored in the Q-Doc Maintenance Log as PDF-files.
- The machine is returned to the customer incl. the Q-Doc-Log CD and hardcopy of all FAT documents, for further qualification (SAT: Site Acceptance Test) and validation (PV: Process Validation).
- Word and PDF documents are stored in the Alfa Laval Q-Doc Maintenance Log folder.

2. **Q-Doc-Spare Part Order** (Item no.: TE24XXXX-90 or TE24XXXX-91, for Inner shaft Pos. 14 and Outer pipe Pos. 12, item no.: TE24XXXX-50)

(This maintenance order should be selected if the customer wishes to carry out service or repair. The customer or the repair shop thus carries the full responsibility for the full traceability of the material and FAT documentation for the Tank Cleaning Machine).

- The spare part is sent to the customer incl. 3.1 Cert. + FDA and USP Class VI Declaration of Compliance incl. Weld-Log documentation (Inner shaft, Outer pipe) as hardcopy.
- This service information will not be recorded in the Alfa Laval Q-Doc folder. The customer has to perform all Qualification tests and documentation (FAT, SAT, IQ & OQ) himself.

Contact local Alfa Laval service and support (see. www.alfalaval.com).

Important information to give to Alfa Laval:

- Serial No.
- Q-Doc maintenance order type:
 - Item no.: TEREQ-Q-doc
 - or
 - Item no.: 24XXXX-90 or -91
 - Item no.: 24XXXX-50
 - (See page 39 for more information)

Maintenance (continued)

Every 150/300 working hours

If the used cleaning media is tap water or commonly used CIP solvents, the recommended maintenance interval is 300 hours. However, if special cleaning media is used such as e.g. WFI, the recommended maintenance interval is 150 hours (see page 46-47).

1. Disassemble machine as described on the following pages.
2. Clean material build-up and deposits from internal parts with water or suitable chemical cleaner, possibly Scotch-brite, S-Ultrafine.
3. Check Slide bearing (Pos. 31) for wear. If endface of Bearing is worn more than 0.5 mm into Slide bearing, it should be replaced. If hole is worn to more than $\varnothing 6.2$ mm, it must be replaced.
4. Check Bearing bush for Turbine shaft (Pos. 38) in Inlet cap. If hole is worn oval to a max. diameter of more than 8,35 mm, Bearing should be replaced. At the same time replace Bearing bushes in Base housing (Pos. 20 + 19).
5. Check Carrier bearing (Pos. 36). If worn to a max. diameter of more than $\varnothing 12.2$ mm, it should be replaced.
6. Check Bearing bushes (Pos. 20 + 19) in Base housing by fitting Output shaft (Pos. 30) and check sideways movement. Replace if necessary. If bushes are worn they will allow Output shaft to tilt and eventually the planet gear will be blocked. Always replace together with Bearing bush (Pos. 38) in Inlet cap.

Note: Timely replacement of bearings for Turbine shaft and Output shaft will prevent costly damage to the gear. However, all Bearing bushes, made from high performance plastic PEEK-material, are mounted with press-fit and should not be removed unless they need to be replaced.

7. Check Planet wheel (Pos. 35) while still mounted in Planet wheel carrier (Pos. 33). It must rotate easily on Shaft. If restriction or much clearance on Shaft is felt, Planet wheel should be dismantled for inspection of Bearing (hole in Planet wheel) and Shaft for Planet wheel (Pos. 34). Max diameter of holes: $\varnothing 6.2$ mm.

Check wear of the teeth.

8. Check unrestricted rotation of Ball bearings. Inspect for build-up of foreign material in Ball rings (Pos. 10 + 4) and Ball races. Balls must rotate freely in Ball rings.
9. Assemble machines as described in the following pages.
10. Check that the machine is in operating condition by blowing compressed air from an air pistol into the inlet. If any resistance is recognised, the machine should be disassembled in order to localise the cause.

In order to ensure current good hygiene it is recommended to replace all rubber seals at each service inspection. Apart from the parts specifically mentioned above, all the remaining wear parts should regularly be inspected for wear. Wear parts are specified in the Reference Lists of Parts, pages 32-37.

Part List Drawing

Toftejorg SaniJet 20 Media Driven complete, Part List Drawing

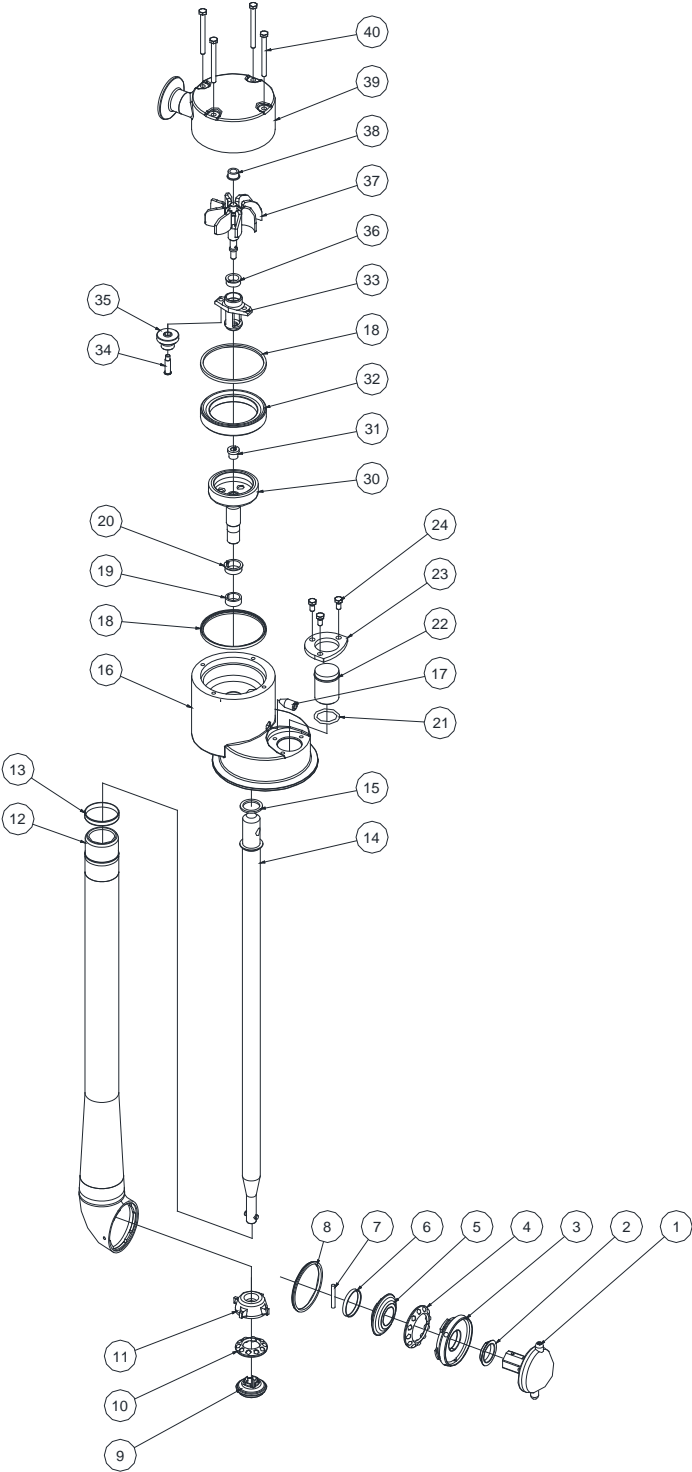

Reference Lists of Parts

Toftejorg SaniJet 20, Media Driven (EPDM as standard)

Pos	Item no. for 4" version	Item no. for 3" version	No/ Unit	Description	Material	Remarks
1	<input type="checkbox"/> TE20B335	TE20B335	1	Cleaner head 2xø3.8mm	Stainless steel	Spare part
	<input type="checkbox"/> TE20B336	TE20B336	1	Cleaner head 4xø4.2mm	Stainless steel	Spare part
2	TE20B554	TE20B554	1	Bearing bush	Polymer	Wear part
3	TE20B552	TE20B552	1	Retaining ring	Stainless steel	Wear part
4	TE20B365	TE20B365	1	Ball ring N	Polymer/Titanium	Wear part
5	TE20B550	TE20B550	1	Bevel gear	Stainless steel	Wear part
6	TE20B571	TE20B571	1	Clip ring	Stainless steel	Spare part
7	TE20B572	TE20B572	1	Pin	Stainless steel	Spare part
8	<input type="checkbox"/> TE20B553	TE20B553	1	Seal ring H	EPDM	Wear part
	<input type="checkbox"/> TE20B553-01	TE20B553-01	1	Seal ring H	FPM (Viton)	Wear part
	<input type="checkbox"/> TE20C553	TE20C553	1	Seal ring H	FFKM	Wear part
9	TE20B542	TE20B542	1	Bevel gear	Stainless steel	Wear part
10	TE20B364	TE20B364	1	Ball ring	Polymer/Titanium	Wear part
11	TE20B539	TE20B539	1	Ball race	Stainless steel	Wear part
12	<input type="checkbox"/> TE20B310	TE20B310	1	Outer tube, L = 350 mm	Stainless steel	Spare part
	<input type="checkbox"/> TE20B311	TE20B311	1	Outer tube, L = 500 mm	Stainless steel	Spare part
	<input type="checkbox"/> TE20B312	TE20B312	1	Outer tube, L = 700 mm	Stainless steel	Spare part
	<input type="checkbox"/> TE20B313	TE20B313	1	Outer tube, L = 1000 mm	Stainless steel	Spare part
	<input type="checkbox"/> TE20B314	TE20B314	1	Outer tube, L = 1200 mm	Stainless steel	Spare part
	<input type="checkbox"/> TE20B315	TE20B315	1	Outer tube, L = 1500 mm	Stainless steel	Spare part
13	TE20B510	TE20B510	1	Bearing ring	Polymer	Wear part
14	<input type="checkbox"/> TE20B538	TE20B538	1	Inner shaft, L = 350 mm	Stainless steel	Spare part
	<input type="checkbox"/> TE20B532	TE20B532	1	Inner shaft, L = 500 mm	Stainless steel	Spare part
	<input type="checkbox"/> TE20B533	TE20B533	1	Inner shaft, L = 700 mm	Stainless steel	Spare part
	<input type="checkbox"/> TE20B534	TE20B534	1	Inner shaft, L = 1000 mm	Stainless steel	Spare part
	<input type="checkbox"/> TE20B535	TE20B535	1	Inner shaft, L = 1200 mm	Stainless steel	Spare part
	<input type="checkbox"/> TE20B536	TE20B536	1	Inner shaft, L = 1500 mm	Stainless steel	Spare part
15	<input type="checkbox"/> TE20B511	TE20B511	1	Plain seal	EPDM	Wear part
	<input type="checkbox"/> TE20B511-01	TE20B511-01	1	Plain seal	FPM (Viton)	Wear part
	<input type="checkbox"/> TE20C511	TE20C511	1	Plain seal	FFKM	Wear part
16	TE24G500	TE24B500	1	Base housing	Stainless steel	Spare part
17	TE20B512	TE20B512	1	Retaining screw	Stainless steel	Spare part
18	<input type="checkbox"/> TE20B516	TE20B516	2	Gasket	EPDM	Wear part
	<input type="checkbox"/> TE20B516-01	TE20B516-01	2	Gasket	FPM (Viton)	Wear part
	<input type="checkbox"/> TE20C516	TE20C516	2	Gasket	FFKM	Wear part
19	TE20B514	TE20B514	1	Bearing bush	Polymer	Wear part

Configuration as delivered marked

Please note that some of the polymer parts are in PEEK, which is not resistant to concentrated sulfuric acid.

Available add-on's

Available add-on's regarding material certificates, Declaration of Compliance and Q-Doc documents, see page 39 for more information.

Reference Lists of Parts (continued)

Toftejorg SaniJet 20, Media Driven (EPDM as standard)

Pos	Item no. for 4" version	Item no. for 3" version	No/ Unit	Description	Material	Remarks
20	TE20B513	TE20B513	1	Bearing bush	Polymer	Wear part
21	<input type="checkbox"/> TE51T127		1	O-ring	EPDM	Wear part
	<input type="checkbox"/> TE51T008		1	O-ring	FPM (Viton)	Wear part
	<input type="checkbox"/> TE51T129		1	O-ring	FFKM	Wear part
22	TE20B642		1	Plug	Stainless steel	Spare part
23	TE24G594		1	Bracket	Stainless steel	Spare part
24	TE51A172		3	Screw	Stainless steel	Spare part
30	TE20B598	TE20B598	1	Output shaft	Stainless steel	Wear part
31	TE20B588	TE20B588	1	Bearing bush	Polymer	Wear part
32	TE20B593	TE20B593	1	Gear ring T2	Stainless steel	Wear part
33	TE20B589	TE20B589	1	Planet wheel carrier	Stainless steel	Spare part
34	TE20B591	TE20B591	1	Shaft f. planet wheel	Stainless steel	Wear part
35	TE20B590	TE20B590	1	Planet wheel T2	Polymer	Wear part
36	TE20B600	TE20B600	1	Bearing bush	Polymer	Wear part
37	TE20B585	TE20B585	1	Impeller w. shaft	Polymer/Stainless steel	Spare part
38	TE20B587	TE20B587	1	Bearing bush	Polymer	Wear part
39	<input type="checkbox"/> TE24B371	TE24B371	1	Inlet cap ø23	Stainless steel	Spare part
	<input type="checkbox"/> TE24B372	TE24B372	1	Inlet cap ø11	Stainless steel	Spare part
40	TE51A224	TE51A224	4	Screw	Stainless steel	Spare part

Configuration as delivered marked

Please note that some of the polymer parts are in PEEK, which is not resistant to concentrated sulfuric acid.

Available add-on's

Available add-on's regarding material certificates, Declaration of Compliance and Q-Doc documents, see page 39 for more information.

Reference Lists of Parts (continued)

Toftejorg SaniJet 20 media driven with improved surface finish (EPDM as standard)

Pos		Item no. for 4" version	Item no. for 3" version	No/ Unit	Description	Material	Remarks
1	<input type="checkbox"/>	TE20E335	TE20E335	1	Cleaner head 2xø3.8mm	Stainless steel	Spare part
	<input type="checkbox"/>	TE20E336	TE20E336	1	Cleaner head 4xø4.2mm	Stainless steel	Spare part
2		TE20B554	TE20B554	1	Bearing bush	Polymer	Wear part
3		TE20E552	TE20E552	1	Retaining ring	Stainless steel	Wear part
4		TE20B365	TE20B365	1	Ball ring N	Polymer/Titanium	Wear part
5		TE20E550	TE20E550	1	Bevel gear	Stainless steel	Wear part
6		TE20E571	TE20E571	1	Clip ring	Stainless steel	Spare part
7		TE20B572	TE20B572	1	Pin	Stainless steel	Spare part
8	<input type="checkbox"/>	TE20B553	TE20B553	1	Seal ring H	EPDM	Wear part
	<input type="checkbox"/>	TE20B553-01	TE20B553-01	1	Seal ring H	FPM (Viton)	Wear part
	<input type="checkbox"/>	TE20C553	TE20C553	1	Seal ring H	FFKM	Wear part
9		TE20E542	TE20E542	1	Bevel gear	Stainless steel	Wear part
10		TE20B364	TE20B364	1	Ball ring	Polymer/Titanium	Wear part
11		TE20E539	TE20E539	1	Ball race	Stainless steel	Wear part
12	<input type="checkbox"/>	TE20E310	TE20E310	1	Outer tube, L = 350 mm	Stainless steel	Spare part
	<input type="checkbox"/>	TE20E311	TE20E311	1	Outer tube, L = 500 mm	Stainless steel	Spare part
	<input type="checkbox"/>	TE20E312	TE20E312	1	Outer tube, L = 700 mm	Stainless steel	Spare part
	<input type="checkbox"/>	TE20E313	TE20E313	1	Outer tube, L = 1000 mm	Stainless steel	Spare part
	<input type="checkbox"/>	TE20E314	TE20E314	1	Outer tube, L = 1200 mm	Stainless steel	Spare part
	<input type="checkbox"/>	TE20E315	TE20E315	1	Outer tube, L = 1500 mm	Stainless steel	Spare part
13		TE20B510	TE20B510	1	Bearing ring	Polymer	Wear part
14	<input type="checkbox"/>	TE20E538	TE20E538	1	Inner shaft, L = 350 mm	Stainless steel	Spare part
	<input type="checkbox"/>	TE20E532	TE20E532	1	Inner shaft, L = 500 mm	Stainless steel	Spare part
	<input type="checkbox"/>	TE20E533	TE20E533	1	Inner shaft, L = 700 mm	Stainless steel	Spare part
	<input type="checkbox"/>	TE20E534	TE20E534	1	Inner shaft, L = 1000 mm	Stainless steel	Spare part
	<input type="checkbox"/>	TE20E535	TE20E535	1	Inner shaft, L = 1200 mm	Stainless steel	Spare part
	<input type="checkbox"/>	TE20E536	TE20E536	1	Inner shaft, L = 1500 mm	Stainless steel	Spare part
15	<input type="checkbox"/>	TE20B511	TE20B511	1	Plain seal	EPDM	Wear part
	<input type="checkbox"/>	TE20B511-01	TE20B511-01	1	Plain seal	FPM (Viton)	Wear part
	<input type="checkbox"/>	TE20C511	TE20C511	1	Plain seal	FFKM	Wear part
16		TE24F500	TE24E500	1	Base housing	Stainless steel	Spare part
17		TE20B512	TE20B512	1	Retaining screw	Stainless steel	Spare part
18	<input type="checkbox"/>	TE20B516	TE20B516	2	Gasket	EPDM	Wear part
	<input type="checkbox"/>	TE20B516-01	TE20B516-01	2	Gasket	FPM (Viton)	Wear part
	<input type="checkbox"/>	TE20C516	TE20C516	2	Gasket	FFKM	Wear part
19		TE20B514	TE20B514	1	Bearing bush	Polymer	Wear part

Configuration as delivered marked

Please note that some of the polymer parts are in PEEK, which is not resistant to concentrated sulfuric acid.

Available add-on's

Available add-on's regarding material certificates, Declaration of Compliance and Q-Doc documents, see page 39 for more information.

Reference Lists of Parts (continued)

Toftejorg SaniJet 20 media driven with improved surface finish (EPDM as standard)

Pos	Item no. for 4" version	Item no. for 3" version	No/ Unit	Description	Material	Remarks
20	TE20B513	TE20B513	1	Bearing bush	Polymer	Wear part
21	<input type="checkbox"/> TE51T127		1	O-ring	EPDM	Wear part
	<input type="checkbox"/> TE51T008		1	O-ring	FPM (Viton)	Wear part
	<input type="checkbox"/> TE51T129		1	O-ring	FFKM	Wear part
22	TE20E642		1	Plug	Stainless steel	Spare part
23	TE24F594		1	Bracket	Stainless steel	Spare part
24	TE20E654		3	Screw	Stainless steel	Spare part
30	TE20E598	TE20E598	1	Output shaft	Stainless steel	Wear part
31	TE20B588	TE20B588	1	Bearing bush	Polymer	Wear part
32	TE20E593	TE20E593	1	Gear ring T2	Stainless steel	Wear part
33	TE20E589	TE20E589	1	Planet wheel carrier	Stainless steel	Spare part
34	TE20E591	TE20E591	1	Shaft f. planet wheel	Stainless steel	Wear part
35	TE20B590	TE20B590	1	Planet wheel T2	Polymer	Wear part
36	TE20B600	TE20B600	1	Bearing bush	Polymer	Wear part
37	TE20B585	TE20B585	1	Impeller w. shaft	Polymer/Stainless steel	Spare part
38	TE20B587	TE20B587	1	Bearing bush	Polymer	Wear part
39	<input type="checkbox"/> TE24E371	TE24E371	1	Inlet cap ø23	Stainless steel	Spare part
39	<input type="checkbox"/> TE24E372	TE24E372	1	Inlet cap ø11	Stainless steel	Spare part
40	TE20E653	TE20E653	4	Screw	Stainless steel	Spare part

Configuration as delivered marked

Please note that some of the polymer parts are in PEEK, which is not resistant to concentrated sulfuric acid.

Available add-on's

Available add-on's regarding material certificates, Declaration of Compliance and Q-Doc documents, see page 39 for more information.

Reference Lists of Parts (continued)

Toftejorg SaniJet 20 media driven, Hastelloy version (FFKM as standard)

Pos	Item no. for 4" version	Item no. for 3" version	No/ Unit	Description	Material	Remarks
1	<input type="checkbox"/> TE20C335	TE20C335	1	Cleaner head 2xø3.8mm	Alloy	Spare part
	<input type="checkbox"/> TE20C336	TE20C336	1	Cleaner head 4xø4.2mm	Alloy	Spare part
2	TE20B554	TE20B554	1	Bearing bush	Polymer	Wear part
3	TE20C552	TE20C552	1	Retaining ring	Alloy	Wear part
4	TE20C361	TE20C361	1	Ball ring N	Polymer/Alloy	Wear part
5	TE20C550	TE20C550	1	Bevel gear	Alloy	Wear part
6	TE20C571	TE20C571	1	Clip ring	Alloy	Spare part
7	TE20C655	TE20C655	1	Pin	Alloy	Spare part
8	TE20C553	TE20C553	1	Seal ring H	FFKM	Wear part
9	TE20C542	TE20C542	1	Bevel gear	Stainless steel	Wear part
10	TE20C360	TE20C360	1	Ball ring	Polymer/Titanium	Wear part
11	TE20C539	TE20C539	1	Ball race	Stainless steel	Wear part
12	<input type="checkbox"/> TE20C310	TE20C310	1	Outer tube, L = 350 mm	Stainless steel	Spare part
	<input type="checkbox"/> TE20C311	TE20C311	1	Outer tube, L = 500 mm	Stainless steel	Spare part
	<input type="checkbox"/> TE20C312	TE20C312	1	Outer tube, L = 700 mm	Stainless steel	Spare part
	<input type="checkbox"/> TE20C313	TE20C313	1	Outer tube, L = 1000 mm	Stainless steel	Spare part
	<input type="checkbox"/> TE20C314	TE20C314	1	Outer tube, L = 1200 mm	Stainless steel	Spare part
	<input type="checkbox"/> TE20C315	TE20C315	1	Outer tube, L = 1500 mm	Stainless steel	Spare part
13	TE20B510	TE20B510	1	Bearing ring	Polymer	Wear part
14	<input type="checkbox"/> TE20C538	TE20C538	1	Inner shaft, L = 350 mm	Stainless steel	Spare part
	<input type="checkbox"/> TE20C532	TE20C532	1	Inner shaft, L = 500 mm	Stainless steel	Spare part
	<input type="checkbox"/> TE20C533	TE20C533	1	Inner shaft, L = 700 mm	Stainless steel	Spare part
	<input type="checkbox"/> TE20C534	TE20C534	1	Inner shaft, L = 1000 mm	Stainless steel	Spare part
	<input type="checkbox"/> TE20C535	TE20C535	1	Inner shaft, L = 1200 mm	Stainless steel	Spare part
	<input type="checkbox"/> TE20C536	TE20C536	1	Inner shaft, L = 1500 mm	Stainless steel	Spare part
15	TE20C511	TE20C511	1	Plain seal	FFKM	Wear part
16	TE24H500	TE24C500	1	Base housing	Alloy	Spare part
17	TE20B512	TE20B512	1	Retaining screw	Stainless steel	Spare part
18	TE20C516	TE20C516	2	Gasket	FFKM	Wear part
19	TE20B514	TE20B514	1	Bearing bush	Polymer	Wear part

Configuration as delivered marked

Please note that some of the polymer parts are in PEEK, which is not resistant to concentrated sulfuric acid.

Available add-on's

Available add-on's regarding material certificates, Declaration of Compliance and Q-Doc documents, see page 39 for more information.

Reference Lists of Parts (continued)

Toftejorg SaniJet 20 media driven, Hastelloy version (FFKM as standard)

Pos	Item no. for 4" version	Item no. for 3" version	No/ Unit	Description	Material	Remarks
20	TE20B513	TE20B513	1	Bearing bush	Polymer	Wear part
21	TE51T129		1	O-ring	FFKM	Wear part
22	TE20C642		1	Plug	Stainless steel	Spare part
23	TE24G594		1	Bracket	Stainless steel	Spare part
24	TE51A172		3	Screw	Stainless steel	Spare part
30	TE20C598	TE20C598	1	Output shaft	Alloy	Wear part
31	TE20B588	TE20B588	1	Bearing bush	Polymer	Wear part
32	TE20C593	TE20C593	1	Gear ring T2	Alloy	Wear part
33	TE20C589	TE20C589	1	Planet wheel carrier	Alloy	Spare part
34	TE20C591	TE20C591	1	Shaft f. planet wheel	Alloy	Wear part
35	TE20B590	TE20B590	1	Planet wheel T2	Polymer	Wear part
36	TE20B600	TE20B600	1	Bearing bush	Polymer	Wear part
37	<input type="checkbox"/> TE20C585	TE20C585		Impeller w. shaft	Assy.	Spare part
	<input type="checkbox"/> TE20B583	TE20B583	1	Impeller	Polymer	Spare part
	<input type="checkbox"/> TE20C582	TE20C582	1	Impeller shaft	Alloy	Wear part
38	TE20B587	TE20B587	1	Bearing bush	Polymer	Wear part
39	<input type="checkbox"/> TE24C371	TE24C371	1	Inlet cap ø23	Alloy	Spare part
	<input type="checkbox"/> TE24C372	TE24C372	1	Inlet cap ø11	Alloy	Spare part
40	TE51A224	TE51A224	4	Screw	Stainless steel	Spare part

Configuration as delivered marked

Please note that some of the polymer parts are in PEEK, which is not resistant to concentrated sulfuric acid.

Available add-on's

Available add-on's regarding material certificates, Declaration of Compliance and Q-Doc documents, see page 39 for more information.

- Blank page -

Reference Lists of Parts (continued)

Available add-on's for Spare parts

Item no.	Description
TE24XXXX-90	<ul style="list-style-type: none"> • Declaration of Compliance: <ul style="list-style-type: none"> - EN 10204 type 3.1 inspection Certificate - FDA Declaration of Compliance - USP Class VI (if possible) - TSE Declaration
TE24XXXX-91 For FPM seals only	<ul style="list-style-type: none"> • Declaration of Compliance: <ul style="list-style-type: none"> - EN 10204 type 3.1 inspection Certificate - FDA Declaration of Compliance - USP Class VI (if possible) - TSE Declaration
TE24XXXX-50 Inner shaft pos no. 12.8 and Outer pipe pos no. 12.10 only	<ul style="list-style-type: none"> • Declaration of Compliance: <ul style="list-style-type: none"> - EN 10204 type 3.1 inspection Certificate - FDA Declaration of Compliance - USP Class VI (if possible) - TSE Declaration • Weld-Log documentation (if necessary) as hardcopy

Maintenance

Dismantling and reassembling, Turbine Unit

Dismantling

1. Remove M5 Screws (Pos. 40). Loosen and unscrew with a Socket wrench (tool no. TE462A).
2. Lift off Inlet cap (Pos. 39). If it is necessary to replace Bearing bush (Pos. 38), remove Bearing bush from Inlet cap. Do not remove Bearing bush unless it must be replaced, as the bush is easily damaged when removed.
3. Withdraw Impeller with Impeller shaft (Pos. 37). Pull off Impeller shaft from Impeller (Pos. 37), (Only TE24HXXX and 24CXXX Hastelloy version).
4. Withdraw the Planet gear (Pos. 33-36).
5. Remove Gasket (Pos. 18) and withdraw the Gear ring (Pos. 32).
6. Withdraw Output shaft (Pos. 30). If it is necessary to replace Bearing bush (Pos. 31), remove Bearing bush from Output shaft. Do not remove Bearing bush unless it must be replaced, as the bush is easily damaged when removed.
7. Remove Gasket (Pos. 18) from Base unit (Pos. 16).
8. Check free rotation of Planet wheel (Pos. 35). Inspect teeth for wear. Also check if any noticeable clearance on shaft is felt. If necessary remove Planet wheel: Carefully knock out Shaft for Planet wheel (Pos. 34). Use suitable mandrel and plastic hammer. If necessary replace Planet wheel and Bearing bush (Pos. 36).

Reassembling

Before reassembly make sure that all parts are clean without deposits or build-up of foreign matter.

1. Remount Planet wheel and Shaft (Pos. 35/34) by carefully knocking Shaft home with plastic hammer. If replaced, observe correct version. Note: Planet wheel carrier has two holes with different center line distance (see sketch page 31).
2. Insert Gasket (Pos. 18) in top of Base unit (Pos. 16).
3. If replaced, insert Bearing bush (Pos. 31) into the Output shaft (Pos. 30) and push home with thumb. Insert the Output shaft (Pos. 30). Check free rotation.
4. Place Gear ring (Pos. 32) on Gasket (Pos. 18) in Base unit (Pos. 16). If replaced, observe correct version.
5. Insert Planet gear into Gear ring (Pos. 32) on top of Bearing bush (Pos. 31). Rotate Planet gear to check correct mesh.
6. Press Impeller onto Impeller shaft (Pos. 37), (Only TE24HXXX and 24CXXX Hastelloy version). Mount Impeller shaft through Planet gear (Pos. 33-36). Rotate to verify correct mesh.
7. Mount Gaskets (Pos. 18) into Inlet cap (Pos. 39).
8. If it is necessary to mount new Bearing bush (Pos. 38) press Bearing bush fully home into the Inlet cap (Pos. 39) with thumb. Mount Inlet cap over Impeller.
9. Mount and tighten Screws (Pos. 40) with Socket wrench (tool no. TE462A). Tighten crosswise. Torque: 3-4 Nm.

Maintenance (continued)

Dismantling and reassembling, Cleaner Unit

Dismantling

1. Loosen Cleaner unit (Pos. 14) with Hook spanner (tool no. TE20B701). Insert carefully into holes in Retaining ring (Pos. 3). Turn counter-clockwise and draw out Cleaner unit. Never use Pipe wrench or any other tool than the Toftejorg SaniJet 20 special Hook spanner, which is developed especially to protect the surface from being damaged.
2. Remove Seal ring (Pos. 8).
3. Pull off Clip ring (Pos. 6). Push out Pin (Pos. 7).
4. Draw off Bevel gear (Pos. 5) together with Ball ring (Pos. 4) and Retaining ring (Pos. 3).
5. If replacement is necessary, pull off Bearing bush (Pos. 2) from Cleaner head (Pos. 1). The Bearing bush should not be removed unless worn or damaged. Wear on this part will increase leakage flow around the front of the Cleaner head, and accordingly increase the total flow rate.

Reassembling

1. If necessary press new Bearing bush (Pos. 2) fully home onto Cleaner head (Pos. 1).
2. Mount Retaining ring (Pos. 3), Ball ring (Pos. 4) and Bevel gear (Pos. 5) on Cleaner head (Pos. 1).
3. Hold Cleaner head and turn Bevel gear to align the groove over the holes in the Cleaner head. Mount Pin (Pos. 7).
4. Secure with Clip ring (Pos. 6) over Pin (Pos. 7). Check that Pin with Clip ring can move axially.
5. Hold Retaining ring (Pos. 3) and check free rotation of Cleaner unit.
6. Insert Seal ring (Pos. 8) into Cleaner house on Outer tube. Make sure that it is fitted correctly into recess.
7. Insert Cleaner unit (Pos. 14) in Outer tube. Correct mounting is made foolproof: Drain hole in Retaining ring must be at the lowest point. Tighten with Hook spanner (tool no. TE20B701).

Caution:



It is important that Seal ring is fitted correctly and that Retaining ring is tightened fully home against "stop". Check that assembly is firmly held in position. If assembly feels loose, replace Seal ring.

Maintenance (continued)

Dismantling and reassembling, Base Unit

Dismantling of Outer tube

In order to dismantle the parts in the Outer tube, it is necessary first to release the Inner shaft (Pos. 14).

Warning: Retaining screw on side of Base housing (Pos. 17) must never be loosened, when machine is mounted in tank unless down pipe is supported and Pressure line is disconnected, as otherwise the complete Down pipe assembly will fall down.



1. Remove Retaining screw (Pos. 17). Loosen and unscrew with a M10 Hex key (Allen key). Pull out Outer tube (Pos. 12) together with Inner shaft (Pos. 14) from Base housing (Pos. 16).
2. Turn Outer tube upside down. Hold Bevel gear (Pos. 9) and push Inner shaft (Pos. 14) approx. 5 mm into Outer tube. Then rotate Inner shaft ¼ revolution, in order for pin in the shaft to pass through grooves in Bevel gear. Remove Bevel gear (Pos. 9) and Ball ring (Pos. 10).
3. Rotate Inner shaft to pass grooves in Ball race (Pos. 11) and pull it out. Tip out Ball race from Outer tube (Pos. 12).
4. If it is necessary to replace Bearing ring (Pos. 13) on Outer tube, pull it off. The Bearing ring should not be removed unless worn or damaged. Wear on this part will increase leakage around Down pipe and accordingly increase total flow rate. It is recommended to replace if diameter is below $\varnothing 38.7$ mm. Diameter must never be below $\varnothing 38.5$ mm.
5. Remove Plain seal (Pos. 15) from Inner shaft (Pos. 14).
6. If necessary, replace Bearing bush (Pos. 20 and 19) in Base housing (Pos. 16).

Reassembling of Outer Tube

1. Mount Plain seal (Pos. 15) on Inner shaft (Pos. 14).
2. Turn Outer tube (Pos. 12) upside down. Fit Ball race (Pos. 11) into Outer tube. Make sure that it is correctly placed in recess.
3. Mount Inner shaft (Pos. 14) from below into the Outer tube. Hold against Ball race (Pos. 11) and fit Inner shaft pin through axial grooves. Place Ball ring (Pos. 10) and Bevel gear (Pos. 9) over Inner shaft on top of the Ball race (Pos. 11). Hold Bevel gear, rotate Inner shaft and draw back to fit pin into groove in the end face of the Bevel gear.
4. Place Base housing (Pos. 16) upside down. Fit upper end of Inner shaft into Base housing. By pressing at the lower end of Inner shaft push the entire assembly into Base housing. Tighten with Retaining screw (Pos. 17).

Maintenance (continued)

Dismantling and reassembling, Base Unit (continued)

Toftejorg SaniJet 20 is as a standard prepared for monitoring by a Rotacheck Sensor (see Rotacheck System page 43). A Plug (Pos. 22) is fitted in the Base housing in the opening designed for the Rotacheck sensor.

Dismantling of Plug or Rotacheck Sensor

1. Remove Screws (Pos. 24). Loosen and unscrew with a Socket wrench (tool no. TE462A).
2. Remove Bracket (Pos. 23).
3. Press up Plug/Rotacheck (Pos. 22). Remove O-ring (Pos. 21).

Reassembling of Plug or Rotacheck Sensor

1. Insert O-ring (Pos. 21) in hole for Rotacheck on Base housing (Pos. 16). Make sure that it is fitted correctly into O-ring groove inside hole. Insert Plug/Rotacheck (Pos. 22).
2. Place Bracket (Pos. 23) over Plug/Rotacheck.
3. Mount and tighten Screws (Pos. 24) with Socket wrench (tool no. TE462A).

Rotacheck System

The Rotacheck System is an ex-proof system, designed for monitoring the operation of the tank cleaning machine. The Sensor is supplied from a special Relay. The Sensor will send a signal to the Relay each time it is hit by a jet from the rotating tank cleaning machine, thus providing verification that the machine is rotating, of the rotation speed, and that the nozzles are not blocked. To install Rotacheck Sensor simply replace Plug (Pos. 22) with Rotacheck Sensor TE52E067. For further information see PD-leaflet and operators manual for Rotacheck system.

Trouble Shooting Guide

Symptom: Slow rotation or failure of machine to rotate

Possible Causes	Fault finding
No or insufficient liquid flow	<p>a). Check if supply valve is fully open.</p> <p>b). Check if inlet pressure to machine is correct</p> <p>c). Check supply line/filter for restrictions/ clogging</p> <p>d). Remove Inlet cap (see page 31) and check for clogging in Impeller area.</p> <p>e). Remove Gear ring and Output shaft (see page 31) and check for clogging in Base housing.</p> <p>f). Remove Cleaner head (see page 41) and check Nozzles and Cleaner head for clogging. If blocked, carefully clean without damaging Nozzles vanes and Nozzle tip. Use air pistol.</p> <p>g). Inspect Bevel gear, Ball ring and Bevel gear inside Outer tube (see page 42). If necessary, remove parts and clean.</p> <p>If large particles repeatedly get jammed in the machine, install filter or reduce mesh size of installed filter in supply line.</p>
Foreign material or material build-up	<p>With air pistol blow air through inlet and check that machine rotates evenly. If any resistance is recognised, disassemble machine in order to localise the cause.</p>
a). Impeller jammed	<p>Remove Turbine shaft with Impeller and Planet gear assembly (see page 31) and remove foreign material.</p>
b). Turbine shaft sluggish in Bearings	<p>Remove Turbine shaft with Impeller (see page 31) and clean Bearings.</p>
c). Planet gear jammed/sluggish	<p>Remove foreign material from Planet wheel and Internal gears. Check rotation of Planet wheel. If restriction is recognised, disassemble Planet gear assembly (see page 31) and remove material build up, especially on Shaft and hole in Planet wheel.</p>

Trouble Shooting Guide (continued)

Possible Causes	Fault finding
d). Output shaft jammed/sluggish	Remove Planet gear assembly (see page 31). Turn Down pipe and check unrestricted rotation. Remove Gear ring and Output shaft. Remove foreign material/material build-up on Output shaft, in holes and Bushes in Base housing.
e). Cleaner unit or Bevel gears jammed/sluggish	Rotate again Down pipe. It must rotate freely without any restriction. If not, remove Cleaner unit (see page 41). Clean out any foreign material and material build-up inside Cleaner head in the bottom of the Outer tube. Hold Retaining ring and rotate Cleaner head. If any restriction is recognised, disassemble Cleaner unit and clean all parts. Balls in ball ring must rotate freely.
f). Down pipe jammed/sluggish	If Down pipe still does not rotate freely without any restriction, it must be disassembled. Clean opening in bottom of Base housing and Bearing ring on Outer tube. Remove Bevel gear, Ball ring and Ball race inside Outer tube and clean parts. Balls in Ball ring must rotate freely without any restriction.

Wear

a). Slide bearings	See page 27-30.
b). Bearing for Turbine shaft	See page 27-30.
c). Planet wheel	See page 27-30.
d). Shaft for Planet wheel	Check clearance of Planet wheel on Shaft. Transverse movement should not exceed 0.3 mm.
e). Turbine shaft	Check clearance in Planet gear, Bearing bush and Bearings for Turbine shaft. Transverse movement should not exceed 0.3 mm. Also inspect teeth for wear.

Mechanical defects

a). Planet wheel. Teeth broken	Replace Planet wheel.
b). Planet wheel can not rotate on Shaft/Shaft bent	Replace Shaft for Planet wheel.
c). Damaged teeth on Bevel gear	Inspect teeth on Bevel gear for deformation. Mount Cleaner Unit in Outer tube (See page 41). Remove Planet gear. Hold Base housing and rotate Down pipe to check that Bevel gears can work together. If damaged: Replace Bevel gears.

Service Kits and Tools

Service Intervals

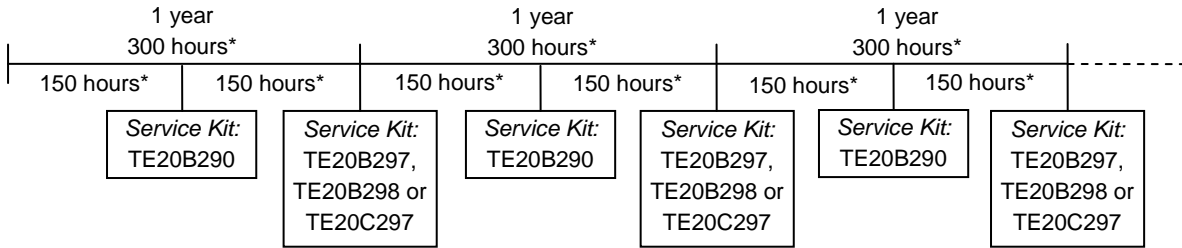

* See page 30 re recommended service intervals

Service Kit in EPDM for Toftejorg SaniJet 20 media driven version

Article no. TE20B297

Pos.	Item no.	No/Unit	Description	Material
38	TE20B587	1	Bearing bushing M	Polymer
36	TE20B600	1	Bearing bushing D1	Polymer
31	TE20B588	1	Bearing bushing	Polymer
18	TE20B516	2	Gasket D	EPDM
21	TE51T127	1	O-ring	EPDM
15	TE20B511	1	Plain seal S	EPDM
13	TE20B510	1	Bearing ring, top	Polymer
20	TE20B513	1	Bearing bush D1	Polymer
19	TE20B514	1	Bearing bush D2	Polymer
8	TE20B553	1	Seal ring H	EPDM
2	TE20B554	1	Bearing bush	Polymer

Service Kit in FPM (Viton) for Toftejorg SaniJet 20 media driven version

Article no. TE20B298

Pos.	Item no.	No/Unit	Description	Material
38	TE20B587	1	Bearing bushing M	Polymer
36	TE20B600	1	Bearing bushing D1	Polymer
31	TE20B588	1	Bearing bushing	Polymer
18	TE20B516-01	2	Gasket D	FPM (Viton)
21	TE51T008	1	O-ring	FPM (Viton)
15	TE20B511-01	1	Plain seal S	FPM (Viton)
13	TE20B510	1	Bearing ring, top	Polymer
20	TE20B513	1	Bearing bush D1	Polymer
19	TE20B514	1	Bearing bush D2	Polymer
8	TE20B553-01	1	Seal ring H	FPM (Viton)
2	TE20B554	1	Bearing bush	Polymer

Available add-on's

Available add-on's regarding material certificates, Declaration of Compliance and Q-Doc documents, see page 39 for more information.

Service Kits and Tools (continued)

Service Kit in FFKM (Perlast) for Toftejorg SaniJet 20 media driven version

Article no. TE20C297

Pos.	Item no.	No/Unit	Description	Material
38	TE20B587	1	Bearing bushing M	Polymer
36	TE20B600	1	Bearing bushing D1	Polymer
31	TE20B588	1	Bearing bushing	Polymer
18	TE20C516	2	Gasket D	FFKM
21	TE51T129	1	O-ring	FFKM
15	TE20C511	1	Plain seal S	FFKM
13	TE20B510	1	Bearing ring, top	Polymer
20	TE20B513	1	Bearing bush D1	Polymer
19	TE20B514	1	Bearing bush D2	Polymer
8	TE20C553	1	Seal ring H	FFKM
2	TE20B554	1	Bearing bush	Polymer

Minor Service Kit for Toftejorg SaniJet 20 media driven version

Article no. TE20B290

Pos.	Item no.	No/Unit	Description	Material
38	TE20B587	1	Bearing bushing M	Polymer
36	TE20B600	1	Bearing bushing D1	Polymer
31	TE20B588	1	Bearing bushing	Polymer

Available add-on's

Available add-on's regarding material certificates, Declaration of Compliance and Q-Doc documents, see page 39 for more information.

Tools

Reference no.	Description
TE462A	8mm Socket Wrench w. pin
TE20B701	Hook spanner

How to Order Spare Parts

On the Part List Drawing page 31 as well as on all instruction drawings, the individual parts have a position number, which is the same on all drawings. From the position number, the part is easily identified in the Reference List of Parts, pages 32-37. Individual parts should always be ordered from the Reference Lists of Parts, clearly stating reference number and description.

Please also quote the type of machine and serial no. This will help us to help you. The serial no. is stamped on the Connection Nipple on the top of the tank cleaning machine.

In cases where spare parts are ordered for machines originally delivered with 3.1 certificates, please state this information on your ordering form together with the machine type and serial number. This is to ensure full traceability henceforward.

In connection with ordering of spare parts for machines originally delivered with Q-doc (Qualification Documentation) please note that all service and repair should be performed by Alfa Laval Tank Equipment, Kolding, Denmark, see page 29 "Service and Repair of machines ordered with Q-Doc".

How to contact Alfa Laval Tank Equipment

For further information please feel free to contact:

Alfa Laval Tank Equipment

Alfa Laval Kolding A/S

31, Albuen - DK 6000 Kolding - Denmark

Registration number: 30938011

Tel switchboard: +45 79 32 22 00 - Fax switchboard: +45 79 32 25 80

www.toftejorg.com , www.alfalaval.dk - info.dk@alfalaval.com

Contact details for all countries are continually updated on our websites.

EU Declaration of Conformity with ATEX Certification

Only valid for EU countries



EC Declaration of Conformity

We

Manufacturer: Alfa Laval Tank Equipment A/S
 Address: Baldershoej 19, DK-2635 Ishoej
 Phone: +45 43 55 86 00
 Fax: +45 43 55 86 01
 E-mail: tankequipment.info@alfalaval.com

herewith declare that the below mentioned product

Tank Cleaning Machine Toftejorg SaniJet 20 Media Driven

3" Connection			4" Connection		
Standard	Improved surface finish	Hastelloy C22	Standard	Improved surface finish	Hastelloy C22
TE24G040_068	TE24F040_068	TE24H040_068	TE24B040_068	TE24E040_068	TE24C040_068

ATEX article index no. -6X, -7X and -8X

is in conformity with the provisions of:

- The Machinery Directive 2006/42/EC, Annex II, Paragraph 1, Part A
- The Regulation (EC) No. 1935/2004
- The Equipment explosive atmospheres (ATEX) Directive 94/9/EC.
- The Pressure Directive 97/23/EC
- FDA 21CFR§177 and 174.6



Harmonised European Standards:
 The machine is manufactured in accordance with the relevant clauses of the following standards:

The Machinery Directive:
 DS/EN ISO 12100-1:2005, DS/EN ISO 12100-2:2005, EN 1672-2:2009

The pressure directive:
 According to its own volume and the rated pressure range the product is regarded an Article 3, par. 3 Equipment.

The ATEX-Directive:
 DS/EN 1127-1:2011, DS/EN 13463-1:2009, DS/EN 13463-5: 2011
 DS/EN ISO/IEC 80079-34, Annex A, paragraph A.5.3 Rotating machines

ATEX Certification:
 EC Type Examination Certificate no. 05ATEX0117X
 Marking: 
 Baseefa Ltd., Notified Body number 1180, Rockhead Business Park, Staden Lane, Buxton, Derbyshire SK17 9RZ, United Kingdom

Place: Ishoej, Denmark	Place: Ishoej, Denmark
Date: July 17, 2012	Date: July 17, 2012
Signature: 	Signature: 
Name and title: Henrik Falster Hansen R&D Manager	Name and title: Denniz Høxbroe ATEX responsible engineer

T:\a\cert\lateral\Declaration of conformity\SaniJet20 media_EC declaration of conformity_ATEX.doc

Declaration of Conformity per EN 10204 Type 2.2

Only valid for EU countries



- 2 -

Non-Metal Materials
Impeller, bearings: 2'CFR§177.24-15 (PEEK450G)
Gaskets, O-rings: 2'CFR§177.2800 (Rubber articles)
Ball ring: 2'CFR§178.170 (C) 1897

Surface Finish
All parts in contact with media are finished with a nominal external surface roughness Ra = 0.8 µm (30 micro inch).

Non-Specific Controls on Product Quality "As-Supplied"
All metallic part material certifications are inspected upon receipt before assembly. Parts inspections are completed according to the approved ISO 9001:2008 standard program. The Quality Control Department only accepts the product in component parts for assembly according to this program if the parts comply with the above material specification documentation.
Product welds are executed, inspected and finished (polished where accessible), according to written, approved procedures.
Parts produced from FDA approved polymers are only sourced from suppliers that have met "pre-qualification" standards established by Alfa Laval Tank Equipment's ISO 9001:2008 program. Materials of construction of component parts are controlled through clear and explicit specifications in purchase orders. These specifications include the materials of construction specified by the parts designers, making them subject to the contractual terms and conditions.

The following item numbers are covered by this certificate:

TE2M040	TE2M044	TE2M060	TE2M066	TE2M040	TE2M044	TE2M060	TE2M066
TE2M041	TE2M046	TE2M061	TE2M068	TE2M041	TE2M046	TE2M061	TE2M068
TE2M042		TE2M062		TE2M042		TE2M062	
TE2M044		TE2M064		TE2M044		TE2M064	

Standard	ATEX	Material (rubber articles)
-0X	-7X	EPDM
-01	-71	FKM (Viton)
-04	-74	FFKM (Perfluor)

Copenhagen, Ischoej, on July 19, 2012
For Alfa Laval Tank Equipment AIS

 Dennis Hørbroe
 Quality Manager



This certificate is delivered in compliance with the latest valid design and construction. Alfa Laval Tank Equipment AIS reserve the right to alter or modify any unit specifications without notice or any obligation.
July 2012



Declaration of Conformity
Per
EN 10204, Sub Clause 2.2 Test Report
Materials of Construction and Surface Finishes

Alfa Laval Tank Equipment AIS (supplier)
declare, under our sole responsibility, that the following product:

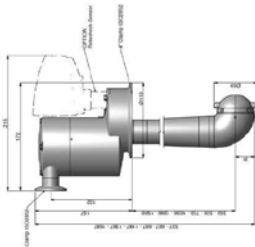
Description: Toftejorg SaniJet20 Media Driven Rotary Jet Head, Right	
--	--

has been subjected to non-specific controls for product quality and is found to conform with the following standards and other normative documents:

Metal Materials
In contact with media: AISI 316L, Werkstoff no. 1.4404
Ball race: SAF 2205, Werkstoff no. 1.4462

Not in contact with media
Screws: A4
Brackets: AISI 316L, Werkstoff no. 1.4404

.../2

This certificate is delivered in compliance with the latest valid design and construction. Alfa Laval Tank Equipment AIS reserve the right to alter or modify any unit specifications without notice or any obligation.
July 2012

Declaration of Conformity per EN 10204 Type 2.2

Only valid for EU countries



- 2 -

Non-Metal Materials
 Impeller, bearings: 2:CFR\$177.2415 (PEEK450G)
 Gaskets, o-rings: 2:CFR\$177.2800 (Rubber articles)
 Ball ring: 2:CFR\$176.170 (C) 1897

Surface Finish
 All parts in contact with media are finished with a nominal surface roughness Ra = 0.5 µm (30 micro inch).

Non-Specific Controls on Product Quality "As-Supplied"
 All metallic part material certifications are inspected upon receipt before assembly. Parts inspections are completed according to the approved ISO 9001:2008 standard program. The Quality Control Department only accepts the product in component parts for assembly according to this program if the parts comply with the above material specification documentation.
 Product welds are executed, inspected and finished (polished where accessible), according to written, approved procedures.
 Parts produced from FDA approved polymers are only sourced from suppliers that have met "pre-qualification" standards established by Alfa Laval Tank Equipment's ISO 9001:2008 program. Materials or construction of component parts are controlled through clear and explicit specifications in purchase orders. These specifications include the materials of construction specified by the parts designers, making them subject to the contractual terms and conditions.
 The following item numbers are covered by this certificate:

TE2MF00	TE2MF04E	TE2MF00	TE2MF06	TE2MF04E	TE2MF00	TE2MF06	TE2MF06
TE2MF01	TE2MF04E	TE2MF01	TE2MF06	TE2MF04E	TE2MF01	TE2MF06	TE2MF06
TE2MF02	TE2MF04E	TE2MF02	TE2MF06	TE2MF04E	TE2MF02	TE2MF06	TE2MF06
TE2MF03	TE2MF04E	TE2MF03	TE2MF06	TE2MF04E	TE2MF03	TE2MF06	TE2MF06

Standard	ATEX	Material (inBeer articles)
-0X	-7X	EPDM
-01	-71	FRM (Viton)
-04	-74	FRM (Perbun)

Copenhagen, Ibrovej, on July 19, 2012
 For Alfa Laval Tank Equipment AS



Dennis Hestbroe
 Quality Manager

This certificate is delivered in compliance with the latest valid design and construction. Alfa Laval Tank Equipment AS reserve the right to alter or modify any unit specifications without notice or any obligation.
 July 2012

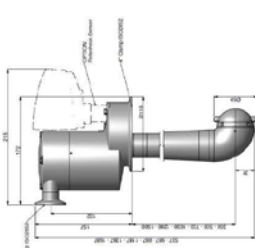

Declaration of Conformity
 Per
EN 10204, Sub Clause 2.2 Test Report
Materials of Construction and Surface Finishes

Alfa Laval Tank Equipment AS (supplier)
 declare, under our sole responsibility, that the following product:

Description: Tofteborg SaniJet20 Media Driven Rotary Jet Head, 0.5 µm Ra Internal/external	
---	---

has been subjected to non-specific controls for product quality and is found to conform with the following standards and other normative documents:

Metal Materials
 In contact with media: ASI 316L Werkstoff no. 1.4404
 Inlet house, cleaner head, shaft, gear wheel and balls: SAF 2205 Werkstoff no. 1.4462
 Ball race:
 Not in contact with media
 Screws: A4
 Brackets: ASI 316L Werkstoff no. 1.4404

.../2

This certificate is delivered in compliance with the latest valid design and construction. Alfa Laval Tank Equipment AS reserve the right to alter or modify any unit specifications without notice or any obligation.
 July 2012

How to contact Alfa Laval

Contact details for all countries are continually updated on our website.

Please visit www.alfalaval.com to access the information directly.

© Alfa Laval Corporate AB

This document and its contents is owned by Alfa Laval Corporate AB and protected by laws governing intellectual property and thereto related rights. It is the responsibility of the user of this document to comply with all applicable intellectual property laws. Without limiting any rights related to this document, no part of this document may be copied, reproduced or transmitted in any form or by any means (electronic, mechanical, photocopying, recording, or otherwise), or for any purpose, without the expressed permission of Alfa Laval Corporate AB. Alfa Laval Corporate AB will enforce its rights related to this document to the fullest extent of the law, including the seeking of criminal prosecution.