



Installation Instructions

BW Seals® Q, QB Series

General Service

Balanced Pusher Seal

Q, QB, QBQ, QBS, QBU, QBQ LZ

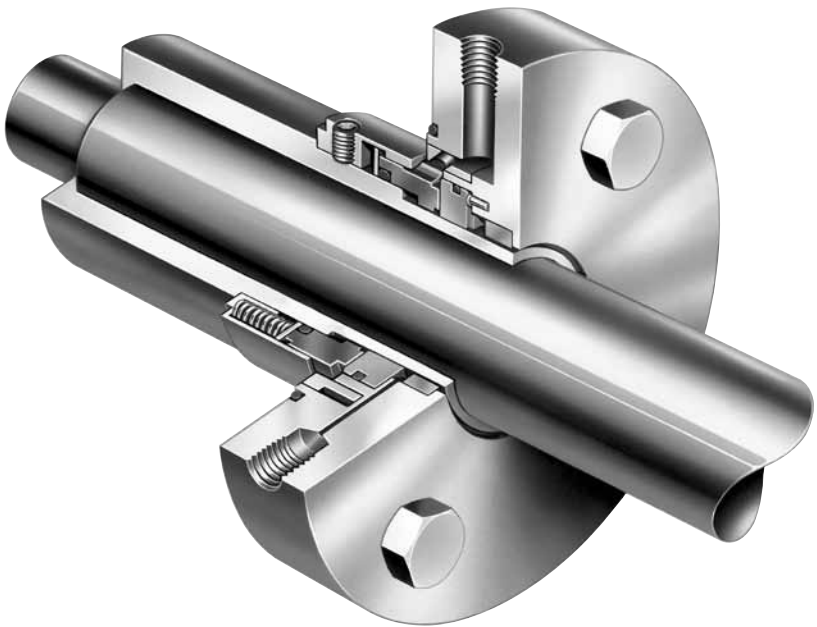

1 Equipment Check

1.1 Follow plant safety regulations:

- lock out motor and valves.
- wear designated personal safety equipment.
- relieve any pressure in system.
- consult plant MSDS files for hazardous material regulations.

1.2 Adjust the bearings, coupling, and impeller so that the shaft is in its operating axial position. This shaft position must be used to check all seal setting (SS) dimensions during installation. **Disassemble equipment to allow access to seal installation area.**

1.3 Remove all burrs, nicks or scratches, and sharp edges from the shaft and sleeve including sharp edges of keyways and threads. Replace worn shaft or sleeve. Make sure the seal housing bore, face, and sealing fluid flush taps are clean and free of burrs and sharp edges that might damage gasket.

Seal Chamber Requirements

Figure 1

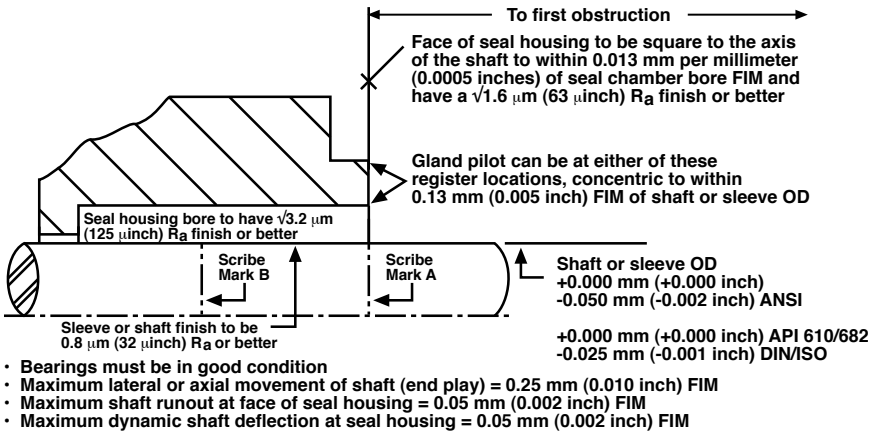

1.4 Check requirements for shaft, sleeve, and seal housing. See Figure 1.

1.5 Check assembly drawing included with the seal for equipment dimensions, seal design, materials of construction, and piping connections.

1.6 Check shaft or sleeve OD, box depth, box bore, and distance to the first obstruction to ensure that they are dimensionally the same as shown on the seal assembly drawing.

1.7 Check gland pilot and bolt holes to ensure they are adaptable to the equipment and are the same as shown on the assembly drawing.

1.8 Handle all seal parts with care, they are manufactured to precise tolerances. The seal faces are of special importance. These two sealing faces are lapped flat to within two light bands (23.2 millionths of an inch).

Keep the seal faces perfectly clean at all times.

The images of parts shown in these instructions may differ visually from the actual parts due to manufacturing processes that do not affect the part function or quality.

2 Assembly of Seal Components

- 2.1 **Prepare rotating assembly for installation.** The rotating assembly is comprised of the spring holder, springs, retaining ring, set screws, rotating face and rotating face gasket. Examine all parts - clean with alcohol or acetone as needed.

Caution: Consult material safety data sheets for proper handling of alcohol or acetone.

- 2.1.1 Install the set screws into the spring holder.

Caution: Set screws must not protrude into spring holder's bore.

- 2.1.2 Install the springs in the spring pockets of the spring holder.

- 2.1.3 Align the retaining ring with the drive keys, compress the springs and rotate the retaining ring so that the notches are no longer aligned with drive keys to retain springs. Check springs to make sure none are bent over.

- 2.1.4 Install the rotating face gasket in the recess of the rear of the rotating face. Lubricate the inside diameter of the rotating face gasket with silicone base grease only, unless otherwise specified on seal drawing.

- 2.1.5 Press down rotating face gasket making sure it is retained in the groove provided.

- 2.1.6 Install the rotating face in the spring holder with the slots in the face aligning with the keys.

- 2.2 **The rotating assembly can now be installed** on the shaft or sleeve. Use caution not to dislodge rotating face gasket. See Figure 2.

Installed Seal Assembly on Shaft or Customer's Sleeve

Figure 2

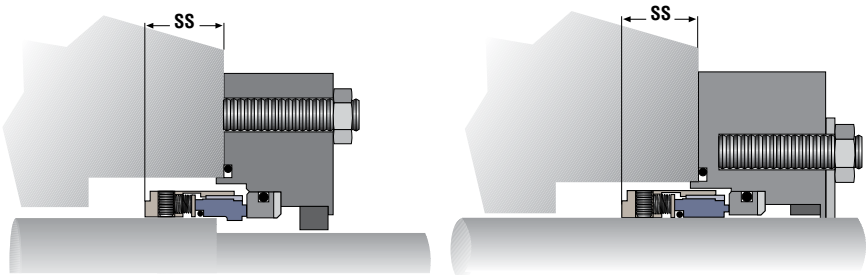

3 Seal Setting for Seal on Shaft or Customer's Sleeve

For proper seal installation, you must obtain the correct seal assembly drawing for your application.

- 3.1 **Inspect pump shaft.** Clean and remove any burrs, nicks, scratches, etc. which could cause damage to gaskets when assembling seal.
- 3.2 **Secure the seal assembly** in place at its correct seal setting position (SS) by tightening the rotating assembly set screws. See Figure 2. Refer to the seal assembly drawing for correct seal setting dimension.

3.3 O-ring Mounted Stationary Face

3.3.1 Assemble seat gasket to stationary face (lubricate gasket with silicone base grease only, unless otherwise specified on seal drawing) and install in gland.

Caution: If anti-rotation pin is used, make sure stationary face is properly seated.

Do not get grease on running face.

3.3.2 Install gland gasket - Use silicone grease if necessary to retain gasket.

3.4 Clamped Stationary Face

3.4.1 Install flat gasket into gland.

3.4.2 Install stationary face into gland.

3.4.3 Install second flat gasket to stationary face.

Note: If two gasket materials are supplied, install PTFE gasket at this location.

Use silicone grease to retain gasket if necessary.

Do not get grease on running face.

3.5 Using lint free tissue, clean stationary and rotating face mating surfaces.

Alcohol or acetone can be used as a cleaning agent to assure clean, film free, dry faces. Any other materials may cause premature seal failure.

Caution: Consult material safety data sheets for proper handling of alcohol or acetone.

3.6 Assemble gland to seal chamber face. See Figure 2.

Caution: During gland assembly over shaft, be sure stationary face is not damaged.

Secure bolts attaching gland to housing.

Note: Even torque is required on all gland bolts to assure proper seal operation.

Tighten gland stud nuts evenly, cross stagger the adjustment of the nuts. Follow the equipment manufacturer's recommendation for gland stud nut torque. In the absence of recommendations, gland stud nuts should only be torqued to establish a leak tight seal at the gasket. Proper gland bolt adjustment is especially important with clamp style inserts where torque may damage the insert. In this case, gland stud nuts should be torqued to a maximum of 13.5 N-m (10 ft-lbs).

4 Hook Sleeve Mount

For proper seal installation, you must obtain the correct seal assembly drawing for your application.

4.1 **Inspect pump shaft.** Clean and remove any burrs, nicks, scratches, etc. which could cause damage to gaskets when assembling seal.

4.2 **Assemble shaft sleeve and flat gasket** to pump shaft and seat in accordance with pump manufacturer's specifications. Inspect for and remove any burrs.

Seal Setting on Hook Sleeve

Figure 3

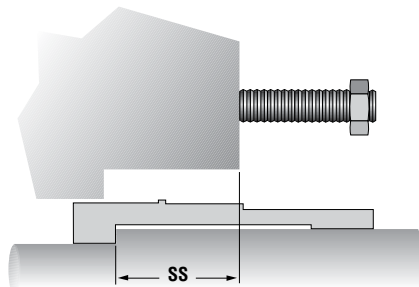

- 4.3 **Verify seal setting (SS)** reference dimension on the seal drawing. This is the dimension from the seal chamber face to a machined step or locator on the shaft. See Figure 3.
- 4.4 If shaft sleeve has no locating shoulder, blue sleeve and scribe line for location of spring holder as shown on seal assembly drawing.
- 4.5 **Slide rotating assembly** onto shaft sleeve, locating in accordance with the seal assembly drawing. Use caution not to dislodge rotating face gasket.
- 4.6 **Tighten seal assembly** set screws to shaft sleeve ensuring seal assembly is retained at proper seal setting location as noted on seal assembly drawing.
- 4.7 **O-ring mounted Stationary Face**
- 4.7.1 Assemble seat gasket to stationary face (lubricate gasket with silicone base grease only) and install in gland.
- Caution:** If anti-rotation pin is used make sure stationary face is properly seated.
Do not get grease on running face.
- 4.7.2 Install gland gasket, use silicon grease if necessary to retain gasket.
- 4.8 **Clamped Stationary Face**
- 4.8.1 Install flat gasket into inner gland.
- 4.8.2 Install stationary face into gland.
- 4.8.3 Install second flat gasket to stationary face.
- Note:** If two gasket materials are supplied, install PTFE gasket at this location. Use silicone grease to retain gasket if necessary.
Do not get grease on running face.
- 4.9 **Using lint free tissue, clean stationary and rotating face** mating surfaces. Alcohol or acetone can be used as a cleaning agent to assure clean, film free, dry faces. Any other materials may cause premature seal failure.
- Caution:** Consult material safety data sheet for proper handling of alcohol or acetone.
- 4.10 **Assemble gland to seal chamber face.** See Figure 4.
- Caution:** During gland assembly over shaft and sleeve, be sure stationary face is not damaged. Secure bolts attaching gland to housing.
- Note:** Even torque is required on all gland bolts to assure proper seal operation. Tighten gland stud nuts evenly, cross stagger the adjustment of the nuts. Follow the equipment manufacturer's recommendation for gland stud nut torque. In the absence of recommendations, gland stud nuts should only be torqued to establish a leak tight seal at the gasket. Proper gland bolt adjustment is especially important with clamp style inserts where torque may damage the insert. In this case, gland stud nuts should be torqued to a maximum of 13.5 N-m (10 ft-lbs).

Installed Seal Assembly on Hook Sleeve

Figure 4

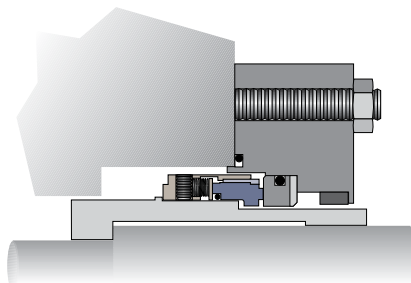

5 Cartridge Mount

- 5.1 **For proper seal installation** you must have current seal assembly drawing for your application.
- 5.2 **Inspect pump shaft.** Clean and remove any burrs, nicks, scratches, etc., which could cause damage to gaskets when installing cartridge seal.
- 5.3 Carefully install the seal onto the shaft and locate against the face of the seal chamber. Take care not to impact the seal cartridge as damage to internal components can occur.
- 5.4 Orient ports on the seal cartridge as shown on the seal assembly drawing.
- 5.5 Evenly torque gland bolts/nuts to prevent uneven gland pressure against the seal chamber.
- 5.6 Adjust bearings, coupling, and impeller so that the shaft is in its final operating position.
- 5.7 Determine the type of setting device used by the seal design and follow the appropriate instructions.

Type 1 - none

Type 2 - setting plates

Type 3 - setting blocks

Type 1 (none)

Figure 5

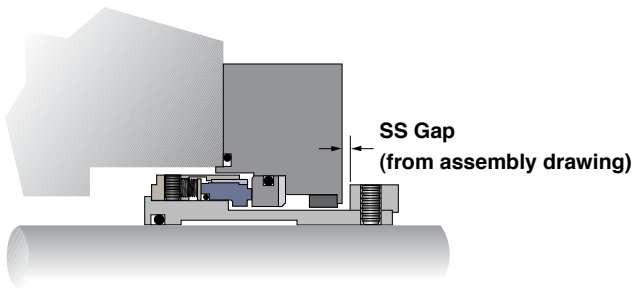

- Determine proper seal setting (SS) gap specified on seal assembly drawing.
- Adjust sleeve drive collar position relative to gland to establish proper gap.
- Tighten drive collar set screws.

Type 2 (setting plates)

Figure 6

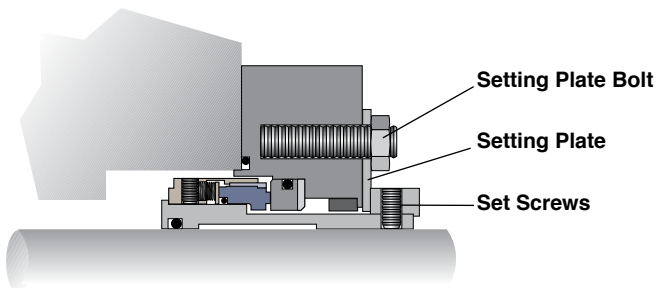

- Tighten drive collar set screws to shaft.
- Loosen setting plate attachment bolts and rotate or slide setting plates clear of drive collar.
- Retighten setting plate attachment bolts.

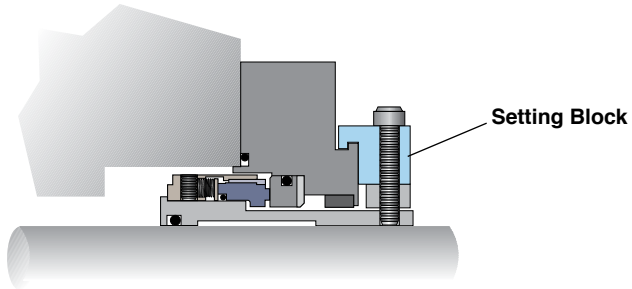

- Tighten drive collar set screws to shaft.
- Loosen and remove setting blocks.

6 Piping Instructions

Do not start up the equipment dry. Vent air from the casing of the pump and the seal chamber before startup.

Refer to assembly drawing for mechanical seal piping instructions.

Note: For special problems encountered during installation, contact your nearest Flowserve Sales and Service Representative or Authorized Distributor.

7 Repair

This product is a precision sealing device. The design and dimension tolerances are critical to seal performance. Only parts supplied by Flowserve should be used to repair a seal. To order replacement parts, refer to the part code and B/M number. A spare backup seal should be stocked to reduce repair time.

When seals are returned to Flowserve for repair, **decontaminate the seal assembly** and include an order marked "**Repair or Replace.**" **A signed certificate of decontamination** must be attached. **A Material Safety Data Sheet (MSDS) must be enclosed** for any product that came in contact with the seal. The seal assembly will be inspected and, if repairable, it will be rebuilt, tested, and returned.



TO REORDER REFER TO
B/M # _____
F.O. _____

FIS135eng REV 07/13 Printed in USA

**To find your local Flowserve representative
and find out more about Flowserve Corporation,
visit www.flowserve.com**

Flowserve Corporation has established industry leadership in the design and manufacture of its products. When properly selected, this Flowserve product is designed to perform its intended function safely during its useful life. However, the purchaser or user of Flowserve products should be aware that Flowserve products might be used in numerous applications under a wide variety of industrial service conditions. Although Flowserve can provide general guidelines, it cannot provide specific data and warnings for all possible applications. The purchaser/user must therefore assume the ultimate responsibility for the proper sizing and selection, installation, operation, and maintenance of Flowserve products. The purchaser/user should read and understand the Installation Instructions included with the product, and train its employees and contractors in the safe use of Flowserve products in connection with the specific application.

While the information and specifications contained in this literature are believed to be accurate, they are supplied for informative purposes only and should not be considered certified or as a guarantee of satisfactory results by reliance thereon. Nothing contained herein is to be construed as a warranty or guarantee, express or implied, regarding any matter with respect to this product. Because Flowserve is continually improving and upgrading its product design, the specifications, dimensions and information contained herein are subject to change without notice. Should any question arise concerning these provisions, the purchaser/user should contact Flowserve Corporation at any one of its worldwide operations or offices.

© 2013 Flowserve Corporation

USA and Canada

Kalamazoo, Michigan USA
Telephone: 1 269 381 2650
Telefax: 1 269 382 8726

Europe, Middle East, Africa

Roosendaal, the Netherlands
Telephone: 31 165 581400
Telefax: 31 165 554590

Asia Pacific

Singapore
Telephone: 65 6544 6800
Telefax: 65 6214 0541

Latin America

Mexico City
Telephone: 52 55 5567 7170
Telefax: 52 55 5567 4224