

***ECPJ centrifugal pumps***

***Installation  
Operation  
Maintenance***

Vertical, single stage sump pump

*Original Instructions*

PCN=71569279, 71569280, 71569281 11-10 (E)

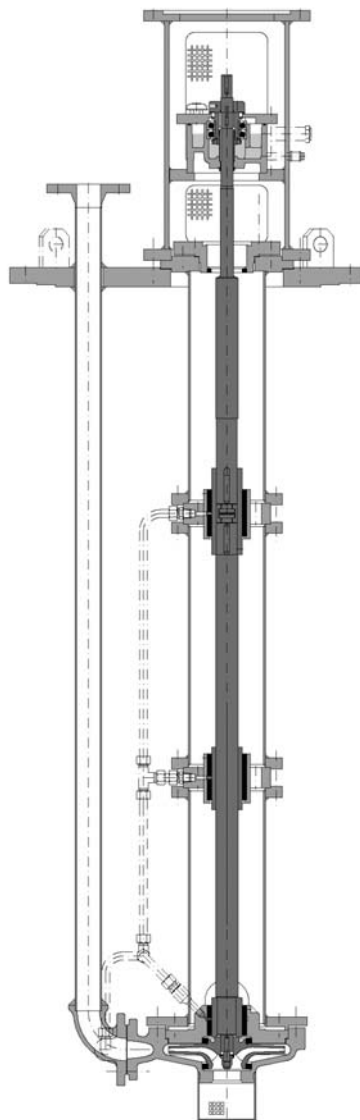

**!** *These instructions should be read prior to installing, operating, using and maintaining this equipment.*

<b>Type:</b>	<b>ECPJ</b>
<b>Size:</b>	<b>Frame</b>
<b>Serial No:</b>	
<b>Customer:</b>	
<b>Customer Order No.:</b>	
<b>Equipment/ Item No.:</b>	
<b>Pumped Liquid:</b>	
<b>Capacity:</b>	<b>m<sup>3</sup>/h</b>
<b>Minimum Capacity:</b>	<b>m<sup>3</sup>/h</b>
<b>Head:</b>	<b>m</b>
<b>Speed:</b>	<b>U/min<sup>-1</sup></b>

**CONTENTS**

	<b>PAGE</b>		
<b>1.0 INTRODUCTION AND SAFETY .....</b>	<b>4</b>	6.8 EXAMINATION OF PARTS.....	28
1.1 GENERAL .....	4	6.9 ASSEMBLY .....	29
1.2 CE MARKING AND APPROVALS .....	4	<b>7.0 AUXILIARIES.....</b>	<b>29</b>
1.3 DISCLAIMER .....	4	7.1 SEAL AND SEAL SYSTEMS .....	29
1.4 COPYRIGHT .....	4	7.2 CHANGING OF MECHANICAL SEAL .....	30
1.5 DUTY CONDITIONS .....	4	<b>8.0 FAULTS; CAUSES AND REMEDIES .....</b>	<b>31</b>
1.6 SAFETY .....	5	<b>9.0 CERTIFICATION.....</b>	<b>33</b>
1.7 WARNING LABEL .....	10	<b>10.0 OTHER RELEVANT DOCUMENTATION AND</b>	
1.8 SPECIFIC MACHINE PERFORMANCE.....	11	<b>MANUALS.....</b>	<b>33</b>
1.9 NOISE LEVEL.....	11	10.1 SUPPLEMENTARY USER INSTRUCTIONS.....	33
1.10 CE DECLARATION .....	13	10.2 CHANGE NOTES.....	33
<b>2.0 TRANSPORT AND STORAGE.....</b>	<b>14</b>	10.3 ADDITIONAL SOURCES OF INFORMATION .....	33
2.1 CONSIGNMENT RECEIPT AND UNPACKING.....	14	10.4 ABBREVIATIONS .....	34
2.2 HANDLING .....	14		
2.3 LIFTING .....	14		
2.4 STORAGE .....	14		
2.5 RECYCLING AND END OF PRODUCT LIFE .....	14		
<b>3.0 DESCRIPTION .....</b>	<b>15</b>		
3.1 CONFIGURATION.....	15		
3.2 NOMENCLATURE.....	15		
3.3 DESIGN OF MAJOR PARTS .....	15		
3.4 PERFORMANCE AND OPERATING LIMITS .....	16		
<b>4.0 INSTALLATION .....</b>	<b>16</b>		
4.1 LOCATION .....	16		
4.2 PART ASSEMBLIES .....	16		
4.3 FOUNDATION .....	16		
4.4 INITIAL ALIGNMENT .....	16		
4.5 PIPING.....	17		
4.6 ELECTRICAL CONNECTIONS .....	18		
4.7 FINAL SHAFT ALIGNMENT CHECK.....	18		
4.8 PROTECTION SYSTEMS .....	18		
<b>5.0 COMMISSIONING START-UP, OPERATION</b>			
<b>AND SHUTDOWN.....</b>	<b>19</b>		
5.1 PRECOMMISSIONING PROCEDURE .....	19		
5.2 PUMP LUBRICANTS.....	19		
5.3 IMPELLER CLEARANCE.....	22		
5.4 DIRECTION OF ROTATION .....	22		
5.5 GUARDING .....	22		
5.6 PRIMING AND AUXILIARY SUPPLIES .....	22		
5.7 STARTING THE PUMP .....	22		
5.8 OPERATION.....	23		
5.9 STOPPING AND SHUTDOWN .....	23		
5.10 HYDRAULIC, MECHANICAL AND ELECTRICAL DUTY			
.....	23		
<b>6.0 MAINTENANCE .....</b>	<b>24</b>		
6.1 GENERAL .....	24		
6.2 MAINTENANCE SCHEDULE .....	24		
6.3 SPARE PARTS .....	25		
6.4 RECOMMENDED SPARES .....	26		
6.5 FASTENER TORQUES.....	26		
6.6 SETTING IMPELLER CLEARANCE.....	27		
6.7 DISASSEMBLY .....	27		

## 1.0 INTRODUCTION AND SAFETY

### 1.1 General



***These Instructions must always be kept close to product's operating location or directly with the product.***

Flowserve's products are designed, developed and manufactured with state-of-the-art technologies in modern facilities. The unit is produced with great care and commitment to continuous quality control, utilising sophisticated quality techniques, and safety requirements.

Flowserve is committed to continuous quality improvement and being at service for any further information about the product in its installation and operation or about its support products, repair and diagnostic services.

These instructions are intended to facilitate familiarization with the product and its permitted use. Operating the product in compliance with these instructions is important to help ensure reliability in service and avoid risks. The instructions may not take into account local regulations; ensure such regulations are observed by all, including those installing the product. Always coordinate repair activity with operations personnel, and follow all plant safety requirements and applicable safety and health laws/regulations.



***These instructions should be read prior to installing, operating, using and maintaining the equipment in any region worldwide. The equipment must not be put into service until all the conditions relating to safety noted in the instructions have been met.***

### 1.2 CE marking and approvals

It is a legal requirement that machinery and equipment put into service within certain regions of the world shall conform with the applicable CE Marking Directives covering Machinery and, where applicable, Low Voltage Equipment, Electromagnetic Compatibility (EMC), Pressure Equipment Directive (PED) and Equipment for Potentially Explosive Atmospheres (ATEX).

Where applicable the Directives, and any additional Approvals, cover important safety aspects relating to machinery and equipment and the satisfactory provision of technical documents and safety instructions. Where applicable this document incorporates information relevant to these Directives. To establish Approvals and if the product itself is CE Marked check the serial number plate and the Certification.

### 1.3 Disclaimer

***Information in these User Instructions is believed to be reliable. In spite of all the efforts of Flowserve Corporation to provide sound and all necessary information the content of this manual may appear insufficient and is not guaranteed by Flowserve as to its completeness or accuracy.***

Flowserve manufactures products to exacting International Quality Management System Standards as certified and audited by external Quality Assurance organisations. Genuine parts and accessories have been designed, tested and incorporated into the products to help ensure their continued product quality and performance in use. As Flowserve cannot test parts and accessories sourced from other vendors the incorrect incorporation of such parts and accessories may adversely affect the performance and safety features of the products. The failure to properly select, install or use authorised Flowserve parts and accessories is considered to be misuse. Damage or failure caused by misuse is not covered by Flowserve's warranty. In addition, any modification of Flowserve products or removal of original components may impair the safety of these products in their use.

### 1.4 Copyright

All rights reserved. No part of these instructions may be reproduced, stored in a retrieval system or transmitted in any form or by any means without prior permission of Flowserve.

### 1.5 Duty conditions

This product has been selected to meet the specifications of your purchaser order. The acknowledgement of these conditions has been sent separately to the Purchaser. A copy should be kept with these instructions.



***The product must not be operated beyond the parameters specified for the application. If there is any doubt as to the suitability of the product for the application intended, contact Flowserve for advice, quoting the serial number.***

If the conditions of service on your purchase order are going to be changed (for example liquid pumped, temperature or duty) it is requested that the user seeks Flowserve's written agreement before start up.

## 1.6 Safety

### 1.6.1 Summary of safety markings

These user instructions contain specific safety markings where non-observance of an instruction would cause hazards. The specific safety markings are:



**DANGER**

This symbol indicates electrical safety instructions where non-compliance will involve a high risk to personal safety or the loss of life.



This symbol indicates safety instructions where non-compliance would affect personal safety and could result in loss of life.



This symbol indicates "hazardous and toxic fluid" safety instructions where non-compliance would affect personal safety and could result in loss of life.



**CAUTION**

This symbol indicates safety instructions where non-compliance will involve some risk to safe operation and personal safety and would damage the equipment or property.



This symbol indicates "strong magnetic field" safety instructions where non-compliance would affect personal safety, pacemakers, instruments or stored data sensitive to magnetic fields.



This symbol indicates explosive atmosphere marking according to ATEX. It is used in safety instructions where non-compliance in the hazardous area would cause the risk of an explosion.



This symbol is used in safety instructions to remind not to rub non-metallic surfaces with a dry cloth; ensure the cloth is damp. It is used in safety instructions where non-compliance in the hazardous area would cause the risk of an explosion.

**Note:**

The sign is not a safety symbol but indicates an important instruction in the assembly process.



This symbol indicates potential risks connected with extremely high temperatures.



This symbol indicates potential risks connected with extremely low temperatures.

### 1.6.2 Personnel qualification and training

All personnel involved in the operation, installation, inspection and maintenance of the unit must be qualified to carry out the work involved. If the personnel in question do not already possess the necessary knowledge and skill, appropriate training and instruction must be provided. If required the operator may commission the manufacturer / supplier to provide applicable training.

Always co-ordinate repair activity with operations and health and safety personnel, and follow all plant safety requirements and applicable safety and health laws/regulations.

### 1.6.3 Safety action

***This is a summary of conditions and actions to help prevent injury to personnel and damage to the environment and to equipment. For products used in potentially explosive atmospheres section 1.6.4 also applies.***



**CAUTION**

PREVENT EXCESSIVE EXTERNAL PIPE LOAD

Do not use pump as a support for piping. Do not mount expansion joints so that their force, due to internal pressure, acts on the pump flange.



**CAUTION**

ONLY CHECK DIRECTION OF MOTOR ROTATION WITH COUPLING ELEMENT/ PINS REMOVED

Starting in reverse direction of rotation will damage the pump.



**CAUTION**

ENSURE CORRECT LUBRICATION

(See section 5 *Commissioning, startup, operation and shutdown.*)

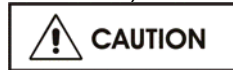

**CAUTION**

START THE PUMP WITH OUTLET VALVE PART OPENED

(Unless otherwise instructed at a specific point in the user instructions.)

This is recommended to avoid the risk of overloading and damaging the pump motor at full or zero flow. Pumps may be started with the valve further open only on installations where this situation cannot occur. Pump outlet valve shall be adjusted to comply with the duty following the run-up process (See section 5 *Commissioning, startup, operation and shutdown.*)

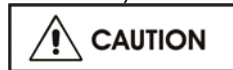

**CAUTION**

START THE PUMP WITH OUTLET VALVE FULLY OPEN

This is recommended to avoid the risk of overloading and damaging the pump motor where greater power is taken at low or shut off flow. Pump outlet valve shall be adjusted to comply with the duty following the

run-up process (See section 5 *Commissioning, startup, operation and shutdown*).

**CAUTION** NEVER RUN THE PUMP DRY

**CAUTION** INLET VALVES TO BE FULLY OPEN WHEN PUMP IS RUNNING  
Running the pump at zero flow or below the recommended minimum flow continuously will cause damage to the seal.

**CAUTION** DO NOT RUN THE PUMP AT ABNORMALLY HIGH OR LOW FLOW RATES  
Operating at a flow rate higher than normal or at a flow rate with no back pressure on the pump may overload the motor and cause cavitation. Low flow rates may cause a reduction in pump/bearing life, overheating of the pump, instability and cavitation/vibration.

**CAUTION** When ambient temperatures are likely to drop below freezing point, the pump and any cooling and flushing arrangements must be drained or otherwise protected.

**HANDLING COMPONENTS**  
Many precision parts have sharp corners and the wearing of appropriate safety gloves and equipment is required when handling these components. To lift heavy pieces above 25 kg (55 lbs) use a crane corresponding to the mass and in accordance with current local regulations.

**DANGER**  
NEVER DO MAINTENANCE WORK WHILST THE UNIT IS CONNECTED TO POWER

**HAZARDOUS LIQUIDS**  
When the pump is handling hazardous liquids care must be taken to avoid exposure to the liquid by appropriate siting of the pump, limiting personnel access and by operator training. If the liquid is flammable and/or explosive strict safety procedures must be applied.

**Gland Packing must not be used when pumping hazardous liquids.**

**DRAIN PUMP AND ISOLATE PIPEWORK BEFORE DISMANTLING THE PUMP**  
The appropriate safety precautions should be taken where the pumped liquids are hazardous.

**FLUORO-ELASTOMERS (When fitted)**  
When a pump has experienced temperatures over 250 °C (482 °F), partial decomposition of fluoro-elastomers (example: Viton) will occur. In this

condition these are extremely dangerous and skin contact must be avoided.

**GUARDS MUST NOT BE REMOVED WHILE PUMP IS OPERATIONAL**

**THERMAL SHOCK**  
Rapid changes in the temperature of the liquid within the pump can cause thermal shock, which can result in damage or breakage of components and should be avoided.

**NEVER APPLY HEAT TO REMOVE IMPELLER**  
Trapped lubricant or vapour could cause an explosion.

**HOT AND COLD PARTS**  
If hot or freezing components or auxiliary heating supplies can present a danger to operators, they must be shielded to avoid accidental contact. If complete protection is not possible, the machine access must be limited to maintenance staff only. Note: bearing housings must not be insulated and drive motors and bearings may be hot.

**If the temperature is greater than 68 °C (155 °F) or below 5 °C (41 °F) in a restricted zone, or exceeds local regulations, action as above shall be taken.**

#### 1.6.4 Products used in potentially explosive atmospheres

Measures are required to:

- Avoid excess temperature
- Prevent build up of explosive mixtures
- Prevent the generation of sparks
- Prevent leakages
- Maintain the pump to avoid hazard

The following instructions for pumps and pump units when installed in potentially explosive atmospheres must be followed to help ensure explosion protection. Both electrical and non-electrical equipment must meet the requirements of European Directive 94/9/EC.

##### 1.6.4.1 Scope of compliance

Use equipment only in the zone for which it is appropriate. Always check that the driver, drive coupling assembly, seal and pump equipment are suitably rated and/or certified for the classification of the specific atmosphere in which they are to be installed.

Where Flowserve has supplied only the bare shaft pump, the Ex rating applies only to the pump. The

party responsible for assembling the pump set shall select the coupling, driver and any additional equipment, with the necessary CE Certificate/ Declaration of Conformity establishing it is suitable for the area in which it is to be installed.

The motor, coupling, pump thrust bearing and seal can be made compliant with 94/9/EC ATEX Directive for Equipment Categories 2 and 3 as required by the duty conditions.

See the pump nameplate and Declaration of Conformity for the pump classification. The pump column below soleplate will also generally be to the same category however in some applications the section of the pump below soleplate and above liquid will have been designed to Category 1, whereas above soleplate Category 2 or 3 will apply. (See section 1.6.4.2.).

The pump will then be supplied with a copy of the Certificate of Approval by a Notified Body and marked with both categories. Users must pay particular attention to pump operation and maintenance instructions because of the hazard of the explosive atmosphere.

The output from a variable frequency drive (VFD) can cause additional heating affects in the motor and so, for pump sets with a VFD, the ATEX Certification for the motor must state that it covers the situation where electrical supply is from the VFD. This is particular requirement still applies even if the VFD is in a safe area.

**1.6.4.2 Marking**

An example of ATEX equipment marking is shown below. The actual classification of the pump will be engraved on the nameplate or in the case of Category 1, below the soleplate on a special ATEX marking plate.

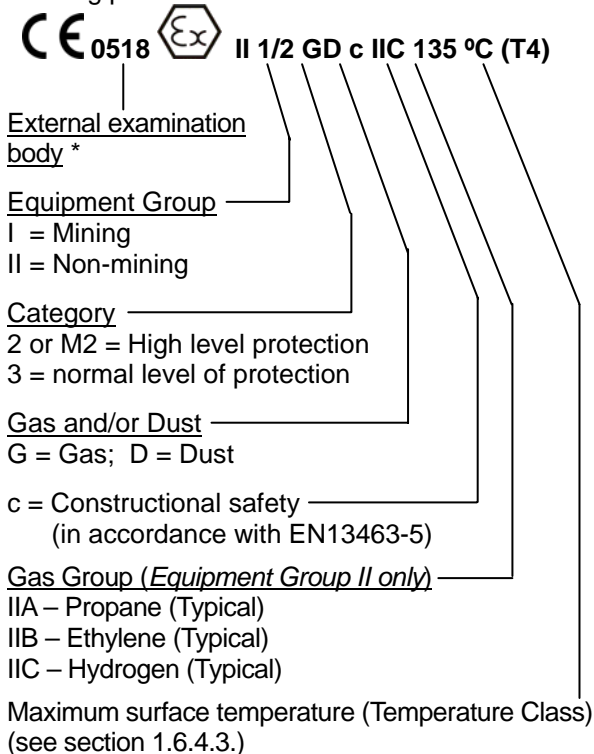

**Note:**

\*The external ATEX examination body reference is included in the pump marking when the Category is 1/2 or 1/3. In that situation, the 1 before the /2 or /3 identifies the special case where the pump is Category 1 below the soleplate and 2 or 3 above the soleplate.

For ATEX Group II Category 1 below the soleplate a special ATEX marking plate is used. An example of this is shown below.

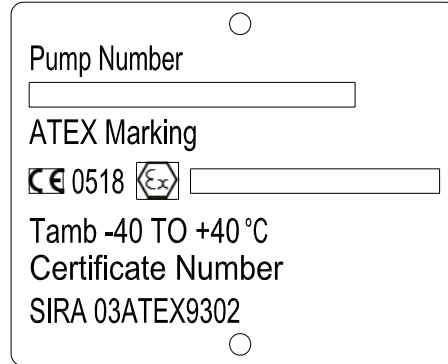

**1.6.4.3 Avoiding excessive surface temperatures**



ENSURE THE EQUIPMENT TEMPERATURE CLASS IS SUITABLE FOR THE HAZARD ZONE

Pumps have a temperature class as stated in the ATEX Ex rating on the nameplate. These are based on a maximum ambient of 40 °C (104 °F); refer to Flowserve for higher ambient temperatures.

The surface temperature on the pump is influenced by the temperature of the liquid handled. The maximum permissible liquid temperature depends on the temperature class and must not exceed the values in the table that follows. The temperature rise at the seals and bearings and due to the minimum permitted flow rate is taken into account in the temperatures stated.

Temperature class to EN 13463-1	Maximum surface temperature permitted	Temperature limit of liquid handled (* depending on material and construction variant - check which is lower)
T6	85 °C (185 °F)	Consult Flowserve
T5	100 °C (212 °F)	Consult Flowserve
T4	135 °C (275 °F)	110 °C (230 °F) *
T3	200 °C (392 °F)	175 °C (347 °F) *
T2	300 °C (572 °F)	270 °C (518 °F) *
T1	450 °C (842 °F)	350 °C (662 °F) *

**The responsibility for compliance with the specified maximum liquid temperature is with the plant operator.**

Temperature classification “Tx” is used when the liquid temperature varies and when the pump is required to be used in differently classified potentially

explosive atmospheres. In this case the user is responsible for ensuring that the pump surface temperature does not exceed that permitted in its actual installed location.

Do not attempt to check the direction of rotation with the coupling element/pins fitted due to the risk of severe contact between rotating and stationary components.

Where there is any risk of the pump being run against a closed valve generating high liquid and casing external surface temperatures it is recommended that users fit an external surface temperature protection device.

Avoid mechanical, hydraulic or electrical overload by using motor overload trips or a Power Monitor and make routine vibration monitoring.

In dirty or dusty environments, regular checks must be made and dirt removed from areas around close clearances, bearing housings and motors.

**The equipment utilises polymer based seals and bearing surfaces that could be corroded if they are in contact with unsuitable liquids or gases. These surfaces are important for the operation of the pump. Contact Flowserve if you are uncertain about the performance of these materials with respect to aggressive substances that may be present in the hazardous area.**

The pump casing must be flooded with liquid to the minimum level on the dimensional General Arrangement (GA) drawing, at any time that the pump is operated. On pumps furnished to Group II Category 1 below the soleplate, monitoring of the level with a pump cut out on low level is required.

For pumps furnished to Category 1/2 and 1/3, if the pump is operating remotely without regular checking, it must be installed with continuous monitoring of vibration level, set to shut down the pump at high vibration levels, see also section 5.8.1.

**1.6.4.4 Preventing the build up of explosive mixtures**



ENSURE THE PUMP IS PROPERLY FILLED AND VENTED AND DOES NOT RUN DRY

Ensure the pump and relevant suction and discharge pipeline system is totally filled with liquid at all times during the pump operation, so that an explosive atmosphere is prevented. In addition it is essential to make sure that seal chambers, auxiliary shaft seal systems and any heating and cooling systems are properly filled.

If the operation of the system cannot avoid this condition the fitting of an appropriate Dry Run protection device is recommended (eg liquid detection or a Power Monitor).

To avoid potential hazards from fugitive emissions of vapour or gas to atmosphere the surrounding area must be well ventilated.

**1.6.4.5 Preventing sparks**



To prevent a potential hazard from mechanical contact the coupling guard must be non-sparking and anti-static.

To avoid the potential hazard from random induced current generating a spark the earth contact on the baseplate must be used.



Avoid electrostatic charge: do not rub non-metallic surfaces with a dry cloth; ensure cloth is damp.

The coupling must be selected to comply with 94/9/EC and correct alignment must be maintained.

**1.6.4.6 Preventing leakage**



The pump must only be used to handle liquids for which it has been approved to have the correct corrosion resistance.

Avoid entrapment of liquid in the pump and associated piping due to closing of suction and discharge valves, which could cause dangerous excessive pressures to occur if there is heat input to the liquid. This can occur if the pump is stationary or running.

Bursting of liquid containing parts due to freezing must be avoided by draining or protecting the pump and ancillary systems.

Where there is the potential hazard of a loss of a seal barrier fluid or external flush, the fluid must be monitored.

If leakage of liquid to atmosphere can result in a hazard, the installation of a liquid detection device is recommended.

**1.6.4.7 Maintenance to the centrifugal pump to avoid the hazard**



CORRECT MAINTENANCE IS REQUIRED TO AVOID POTENTIAL HAZARDS WHICH GIVE A RISK OF EXPLOSION



***The responsibility for compliance with maintenance instructions is with the plant operator.***

To avoid potential explosion hazards during maintenance, the tools, cleaning and painting materials used must not give rise to sparking or adversely affect the ambient conditions. Where there is a risk from such tools or materials, maintenance must be conducted in a safe area.

It is recommended that a maintenance plan and schedule is adopted (see section 6, *Maintenance*).to include the following.

- a) Any auxiliary systems installed must be monitored, if necessary, to ensure they function correctly.
- b) Gland packings must be adjusted correctly to give visible leakage and concentric alignment of the gland follower to prevent excessive temperature of the packing or follower.
- c) Check for any leaks from gaskets and seals. The correct functioning of the shaft seal must be checked regularly
- d) Check bearing lubricant level, and if the hours run show a lubricant change is required.
- e) Check that the duty condition is in the safe operating range for the pump.
- f) Check vibration, noise level and surface temperature at the bearings to confirm satisfactory operation.
- g) Check dirt and dust is removed from areas around close clearances, bearing housings and motors.
- h) Check coupling alignment and re-align if necessary.

1.7 Warning label

**FLOWSERVE** (Austria GmbH)  
Pump Division



# ! WARNING

ESSENTIAL PROCEDURES BEFORE STARTING!

INSTALL AND OPERATE EQUIPMENT ONLY IN ACCORDANCE WITH THE INSTRUCTION MANUAL SUPPLIED SEPERATELY!

ENSURE GUARDS ARE SECURELY IN PLACE!

ENSURE CORRECT DIRECTION OF ROTATION!

ENSURE ALL EXTERNAL CONNECTIONS TO THE PUMP/ SHAFT SEALING AND DRIVER ARE CONNECTED AND OPERATIONAL!

FILL PRIME UNIT AND SYSTEM. DO NOT RUN DRY!

ENSURE UNIT ON A FIRM FOUNDATION AND THAT COUPLING FACES ARE IN CORRECT ALIGNMENT PRIOR TO AND AFTER BOLTING BASEPLATE DOWN AND FIXING PIPEWORK.

SEE MANUAL FOR TOLERANCES.

ENSURE CORRECT DRIVER DIRECTION OF ROTATION WITH COUPLING ELEMENT/ PINS REMOVED. OTHERWISE SERIOUS DAMAGE MAY RESULT!

# ! CAUTION



THIS MACHINE MUST BE FILLED WITH OIL BEFORE STARTING!



FAILURE IN FOLLOWING THESE PROCEDURES MAY RESULT IN PERSONAL INJURY/ OR EQUIPEMENT DAMAGE!

## 1.8 Specific machine performance

For performance parameters see section 1.5, *Duty conditions*. When the Contract requirement specifies these to be incorporated into user instructions these are included here. Where performance data has been supplied separately to the purchaser these should be obtained and retained with these user instructions if required.

## 1.9 Noise level

Attention must be given to the exposure of personnel to the noise, and local legislation will define when guidance to personnel on noise limitation is required, and when noise exposure reduction is mandatory. This is typically 80 to 85 dBA.

The usual approach is to control the exposure time to the noise or to enclose the machine to reduce emitted sound. You may have already specified a limiting noise level when the equipment was ordered, however if no noise requirements were defined, then attention is drawn to the following table to give an indication of equipment noise level so that you can take the appropriate action in your plant.

Pump noise level is dependent on a number of operational factors, flow rate, pipework design and acoustic characteristics of the building, and so the values given are subject to a 3 dBA tolerance and cannot be guaranteed.

Similarly the motor noise assumed in the “pump and motor” noise is that typically expected from standard and high efficiency motors when on load directly driving the pump. Note that a motor driven by an inverter may show an increased noise at some speeds.

If a pump unit only has been purchased for fitting with your own driver then the “pump only” noise levels in the table should be combined with the level for the driver obtained from the supplier.

Consult Flowserve or a noise specialist if assistance is required in combining the values.

It is recommended that where exposure approaches the prescribed limit, then site noise measurements should be made.

The values are in sound pressure level  $L_{pA}$  at 1 m (3.3 ft) from the machine, for “free field conditions over a reflecting plane”.

For estimating sound power level  $L_{WA}$  (re 1 pW) then add 14 dBA to the sound pressure value.

Frame 1	dB(A) Value	Octave MID BAND frequency [Hz]							
		63	125	250	500	1 K	2 K	4 K	8 K
1450 rpm	57	47	51	51	49	49	49	47	42
1760 rpm	59	49	53	53	51	51	51	49	44
2900 rpm	61	51	55	55	53	53	53	51	46
3600 rpm	63	53	57	57	55	55	55	53	48
<b>Frame 2</b>									
1450 rpm	62	52	56	56	54	54	54	52	47
1760 rpm	64	54	58	58	56	56	56	54	49
2900 rpm	66	56	60	60	58	58	58	56	51
<b>Frame 3</b>									
1450 rpm	64	54	58	58	56	56	56	54	49
1760 rpm	66	60	60	58	58	56	51	46	46
2900 rpm	69	59	63	63	61	61	61	59	54
<b>Frame 4</b>									
1450 rpm	71	61	65	65	63	63	63	61	56
1760 rpm	73	63	67	67	65	65	65	63	58

Sound pressure readings are for information only and are not subject to guarantee by Flowserve/IDP.  
 Decibel readings do not include driver or system noise.  
 Pump tested at 100% of the best efficiency point at max. impeller diameter with water.

dB correction for combining noises (pump+motor)

Difference between two levels to be combined, dB	0	1	2	4	6	9	10
Add to the higher level to obtain the combined noise level, dB	3	2.5	2	1.5	1	0.5	0





**Note :**

- 1) The values showed are measured at a distance of 1 mt. (horizontally) from major pump surfaces and 1.5 mt. above the floor.
- 2) The values shown are expressed in dB (A)
- 3) For Noise Test Procedure refer to Works Standard L-109
- 4) The values shown have been derived from actual noise-test data and are based on the following conditions:
  - Equipment is located in a free field above a reflecting plane in which the reduction in noise level in all directions is 6db in each octave band for each doubling of distance.
  - Background noise is 10dB minimum below all noise levels in each octave band.
  - The values shown are at a distance of 1 meter (horizontally) from the major pump surface and 1,5 meters above the floor, using a standard pressure reference of 0,00002 newton per square meter.
  - Overall noise level, dB(A) is determined at points of maximum noise level and the values of all mid-band frequencies are basis A scale readings.

When the required condition flow is outside the range of 75 to 125% BEP, a part load correction (PLC) must be added to the noise level as follows:

Percent of BEP @ required impeller diameter	PLC in dB
74 to 62 or 126 to 136	+1
61 to 50 or 137 to 150	+2
49 to 38	+3
37 to 25	+4

1.10 CE Declaration

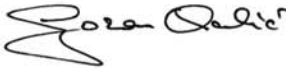
	
<p>Austria , A-2345 Brunn am Geb., Industriestraße B Nr. 6, Tel:++43 2236 31530, Fax: ++43 2236 33430</p>	
<h2 style="margin: 0;">DECLARATION OF CONFORMITY</h2>	
<p><b>Section 1.0 MACHINE DESCRIPTION</b></p> <p>Serial No          Equipment/Item          Purchase Order          Model / Type          MAWP <span style="float: right;">barg</span>            Hydro. Pressure <span style="float: right;">barg</span>          Material          Date DD/MM/YY          Flow <span style="float: right;">m³/h</span>          Head <span style="float: right;">m</span>          Speed Min-1 / RPM          Motor kW          Hz          Volts          Amps          Connection          Country of Destination</p>	
<p><b>Section 2.0 APPLICABLE DIRECTIVES / REGULATIONS</b></p> <ul style="list-style-type: none"> <li>- Machinery Directive 2006/42/EC Annex IIA</li> <li>- EMC Directive 2004/108/EC</li> <li>Low Voltage Directive 2006/95/EC (73/23/EEC text identical). Only applicable to products with electrical devices with voltage input 50-1000 VAC and not applicable to hazardous areas to 94/9/EC (ATEX).</li> <li>Explosive Atmospheres Directive 94/9/EC (ATEX). Only applicable when the  marking appears in section 1.0 Equipment without the  marking must not be used in potentially explosive atmospheres.</li> <li>- Notified Body holding the ATEX Technical Dossier - SIRA (518) Eccleston, ChesterCH4 9JN, United Kingdom</li> </ul>	
<p><b>Section 3.0 APPLICABLE STANDARDS / SPECIFICATIONS</b></p> <ul style="list-style-type: none"> <li>- EN809:1998+A1 :2009, EN953:1997+A1 :2009, ISO13857:2008, ISO12100-1:2003+A1 :2009, ISO12100-2:2003+A1 :2009</li> <li>- EN13463-1:2009, EN13463-5:2003, EN13463-6:2004, EN13463-8:2003 (when applies for compliance with 94/9/EC)</li> <li>- API 610 8<sup>th</sup>, 9<sup>th</sup> or 10<sup>th</sup> ed. as applicable</li> <li>- API 682 1<sup>st</sup>, 2<sup>nd</sup> or 3<sup>th</sup> ed. as applicable</li> </ul>	
<p><b>Section 4.0 DECLARATION</b></p> <p>We, Flowserve (Austria) GmbH, at the above address, declare that under our sole responsibility for the supply of the machinery defined in <b>SECTION 1.0</b> above, the said machinery complies with all the applicable Directives and Regulations set out in <b>SECTION 2.0</b> above and with all the essential health and safety requirements applying to it when installed, operated and maintained in accordance with the applicable User Instruction manual(s).</p> <div style="text-align: center; margin-top: 20px;">  </div> <div style="display: flex; justify-content: space-between; margin-top: 10px;"> <div style="text-align: center;"> <p>Signed: Dipl.Ing.Goran Rakic              Authorised Techn.Manager</p> </div> <div style="text-align: right;"> <p>Date: 24.11.2010</p> </div> </div>	

## 2.0 TRANSPORT AND STORAGE

### 2.1 Consignment receipt and unpacking

Immediately after receipt of the equipment it must be checked against the delivery and shipping documents for its completeness and that there has been no damage in transportation.

Any shortage and or damage must be reported immediately to Flowserve and received in writing within one month of receipt of the equipment. Later claims cannot be accepted.

Check any crates, boxes and wrappings for any accessories or spare parts which may be packed separately with the equipment or attached to side walls of the box or equipment.

Each product has a unique serial number. Check that this number corresponds with that advised and always quote this number in correspondence as well as when ordering spare parts or further accessories.

### 2.2 Handling

Boxes, crates, pallets or cartons may be unloaded using fork lift vehicles or slings dependent on their size and construction.

### 2.3 Lifting

 To avoid distortion, the pump unit should be lifted as shown.

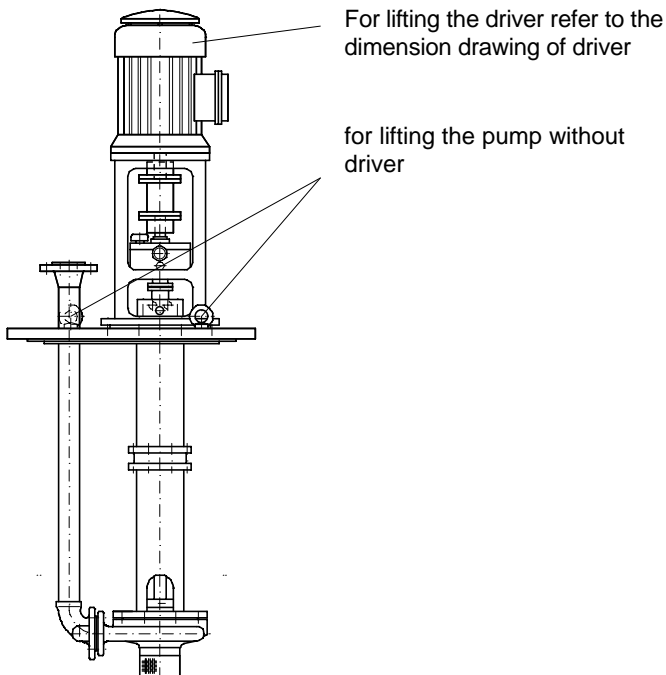

Depended on the pump size the pump unit is packed separately from the driver.

 A crane must be used for all pump sets in

excess of 25 kg (55 lb). Fully trained personnel must carry out lifting, in accordance with local regulations. The driver and pump weights are recorded on their respective nameplates.

### 2.4 Storage

If the pump will not be put immediately into service, it should be stored in a dry room. To avoid any damage during the storage period, the influence of any low or high frequency vibration must be totally inhibited. If the pump is delivered sealed in a plastic-wrapper, it is of max. importance to avoid any damage of that wrapper, because this will protect the pump against humidity. Therefore it must be checked if this wrapper has become cracked and if so, the wrapper must be renewed. If a vertical pump will be stored in horizontal position, be sure to support the pump sufficiently to avoid any deformation or bending of the pump. To avoid the presence of dust and humidity on the driver, it shall also be wrapped in the same way.

#### 2.4.1 Long period storage

If the pump is delivered in a plastic bag, the preservations stands up for one year. If the storage period exceeds this time, the preservation must be checked and renewed. Also the air tight plastic bag must be changed. Moreover we recommend to order a Flowserve Service Engineer for checking the pump before the first start up.

### 2.5 Recycling and end of product life

At the end of the service life of the product or its parts, the relevant materials and parts should be recycled or disposed of using an environmentally acceptable method and local regulations. If the product contains substances, which are harmful to the environment, these should be removed and disposed of in accordance with current regulations. This also includes the liquids and or gases in the "seal system" or other utilities.

 Make sure that hazardous substances are disposed of safely and that the correct personal protective equipment is used. The safety specifications must be in accordance with the current regulations at all times.

### 3.0 DESCRIPTION

#### 3.1 Configuration

The model ECPJ covers the highly engineered specialty end of the Flowserve family of sump pumps. The pump line is based on a modular system, thus providing maximum design and operating flexibility. This is combined with specific design features, including stiff shaft construction, a self-contained axial thrust bearing housing and special materials (Superduplex) for various kind of services. Altogether this makes the ECPJ the pump of choice for the most critical applications, like oil sludge, crude oil water mixtures, ect. The pump can be manufactured with various hydraulic configurations, to meet the requirements of the fluid. Liquid is surged from pit or tank and is discharging the liquid via the discharge pipe to the discharge flange located above the base plate.



The sense of rotation of the pump is clockwise (CW), looking from the coupling to the shaft end of the pump.

#### 3.2 Nomenclature

Example:

ECPJ 32-250-X

<b>ECPJ</b>	Vertical sump pump
<b>No X</b>	closed impeller with back vanes
<b>R</b>	closed impeller with back wear rings
<b>F</b>	Free Flow impeller with back vanes
<b>O</b>	semi open impeller with back vanes

**32** discharge nozzle on pump casing in mm

**250** nominal impeller size in mm

**add.:**

I	indicates Inducer as option
H	heat jacketed
E	oil filled version

#### 3.3 Design of major parts

##### 3.3.1 Motor stool

The motor stool supports the thrust bearing. On top the driver is mounted.

##### 3.3.2 Baseplate

For wet pit installations a rectangular baseplate will be provided. For installation on a tank the baseplate

is manufactured according to ISO/ANSI flange standards.

##### 3.3.3 Line bearings

The shaft is supported by fluid lubricated line bearings, which are flushed internally by the pumpage or externally by clean fluid.

##### 3.3.4 Hydraulics

###### 3.3.4.1 Closed impeller

Both, the impeller and pump casing have renewable front and back wear rings. Above a certain impeller size, the axial thrust is balanced by balancing holes.

###### 3.3.4.2 Closed impeller with back vanes

This is the standard version. The impeller is equipped with back vanes for axial thrust balancing.

###### 3.3.4.3 Free flow impeller

The impeller has straight radial vanes and is mounted recessed in the pump casing. The axial thrust is balanced by back vanes.

###### 3.3.4.4 Inducer

All different impellers can be optionally equipped with an inducer for low NPSHA applications.

###### 3.3.4.5 Semi open impeller

The pump casing is equipped with an integrated wear plate. The axial thrust is balanced by back vanes.

##### 3.3.5 Heat jacketed version

For crystallizing fluids, e.g. liquid sulphur, a fully heat jacketed version is available, including discharge pipe, columns and pump casing.

###### 3.3.5.1 Procedure of Preheating the pump before Start-up

Before priming the pump preheat it for at least one hour to avoid any distortion.

**Note:**

Refer to General Arrangement drawing for required steam pressure and flowrate.



Dry steam shall be used to avoid condensation and a condensate lock in the heat jacket.

##### 3.3.6 Oil filled version

Special arrangement with dry column pipes. Line bearings are life time lubricated deep groove ball bearings. At the bottom a double mechanical seal, filled with oil between themselves, seals against the the pumpage. An expeller in front of the inner mechanical seal prevents the seal surface from any dirt. The location of the expeller discharge ensures an

air gap in front of the inner mechanical seal to avoid any contact with the pumpage. This type of arrangement is used for very contaminated fluids.

### 3.4 Performance and operating limits



In the interest of operator safety the unit must not be operated above the nameplate conditions. Such operation could result in unit failure causing injury to operating personnel. Consult instruction book for correct operation and maintenance of the pump and its supporting components.

## 4.0 INSTALLATION



Equipment operated in hazardous locations must comply with the relevant explosion protection regulations, see section 1.6.4, *Products used in potentially explosive atmospheres*.

### 4.1 Location

The pump should be located to allow room for access, ventilation, maintenance and inspection with ample headroom for lifting and should be as close as practicable to the supply of liquid to be pumped.

Refer to the general arrangement drawing for the pump set.

### 4.2 Part Assemblies

Usually the pumps are delivered completely mounted and adjusted; also the shaft seal is in the correct position. So no further axial alignment of the rotor is necessary. If drivers and/or seal systems are delivered separately, follow the assembly procedure in section 6.9.

### 4.3 Foundation

The foundation shall be located on a place that allows a minimum of pipe work and that is easily accessible for inspection during operation. According to the environment the foundation may consist of concrete or of steel. It must be rigid and heavy enough to absorb normal vibrations and shocks. The baseplate must be supported on the whole surface. It should be at least 20 - 30 mm (0.8 – 1.2 in) higher than the surrounding to avoid the deposit of dust and humidity.

#### 4.3.1 Vertical alignment

Vertical alignment is done with levelling screws. Use a spirit level for correct horizontal alignment of the baseplate.



The max. vertical misalignment is 0.5 mm/m pump length.

#### 4.3.2 Steel foundation

When the pump unit is mounted directly on structural steel frame, it shall be well supported by constructural beams. It is recommended to check the natural frequency of the steel frame, because it shall not coincide with the pump speed. The baseplate has to be fixed on a flat surface with studs or hex screws, the exact horizontal alignment is very important!

#### 4.3.3 Concrete foundation

A concrete foundation must have an exact horizontal alignment and must be placed on solid ground. First a basic foundation shall be built with square shaped holes for embedding the foundation bolts. After putting the baseplate in the foundation the proper alignment can be obtained by adjusting it with shims. Now insert the foundation bolts and grout the space between the basic foundation and the baseplate with grouting cement (refer to illustration)

It is very helpful to use a properly made and stable wooden frame around the baseplate. So the grouting cement will not flow a side. When the grouting is totally set and hardened the foundation bolts shall be tightened in a firm and symmetrical way.

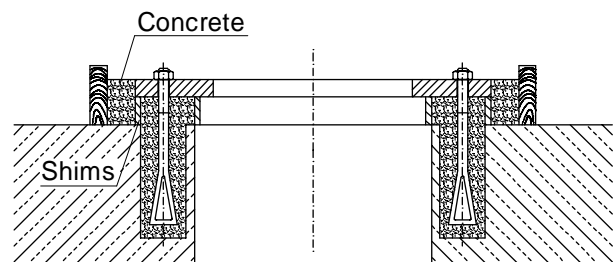

### 4.4 Initial alignment

The adjustment of motor and pump must be checked (if necessary, make a new adjustment) before first start up of the unit.

The motor flange is equipped with adjustment-screws on the motorstand. (Values for adjustment are specified in the coupling instruction manual).

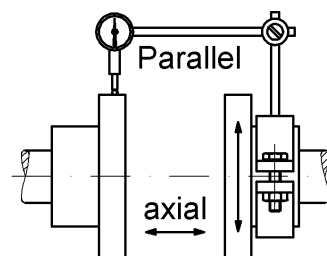

Ensure pump and driver are isolated electrically and the half couplings are disconnected.



Align the motor to the pump, not the pump to the motor. Alignment of the motor is achieved by using the adjustment screws.

**4.4.1 Permissible misalignment limits at working temperature**

When checking parallel alignment, the total indicator read-out (TIR) shown is twice the value of the actual shaft displacement.



The pump is only pre-aligned! Carefully check and readjust alignment before start of the unit. Take out the spacer of the coupling and check the alignment of shafts end of pump and driver. The maximum parallel offset should not exceed 0.05 mm (0.002 in.) and the axially offset can be  $\pm 1$  mm (0.04 in.).



For more details refer to the manufacturer's instruction manual of coupling.

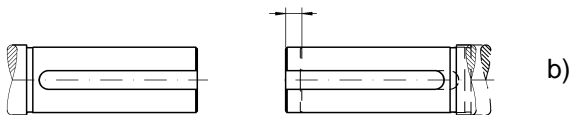
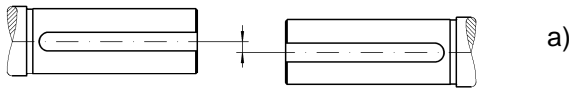

- a) Parallel Offset: The median lines run parallel. The maximum allowable parallel offset depends on the size of coupling and is indicated in the instruction manual of manufacturer of coupling
- b) Axially Offset: Another offset is the displacement of one or both of the shafts. A typical example is thermal expansion.

**Note:** The DBSE (distance between shaft ends) is shown on the General Arrangement Drawing and is larger than the length of the coupling spacer. This is necessary to compensate all manufacturing tolerances of intermediate shafts and column pipes and to allow correct axial adjustment of the rotor (refer to 5.3.1 *Adjusting of the rotor*). For installation of the coupling spacer the coupling hub on the pump shaft must be axially moved to match the spacer. This results in an axial clearance "x" between coupling hub and shaft end, which is taken into account by the coupling selection.

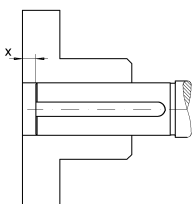

How the alignment of the coupling should be done you can see on the sketches and explanations below!

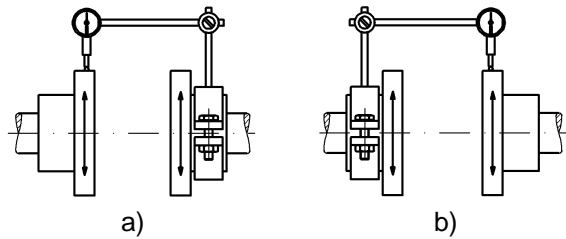

- a) Fix the dial gauge on the driven shaft and check the concentricity by turning of both hubs; correct it if necessary.
- b) Fix the dial gauge on the top shaft and check the concentricity by turning of both hubs; correct it if necessary.

If the pump is handling hot liquid, the alignment must be rechecked in warm condition of the unit. The alignment of the unit shall be checked again after 200 service hours.

**4.5 Piping**

**4.5.1 General**

Protective covers are fitted to the pipe connections to prevent foreign particles entering during transportation and installation. Ensure that these covers are removed from the pump before connecting any pipes.

Maximum forces and moments allowed on the pump flanges vary with the pump size and type. To minimize these forces and moments which may cause misalignment, hot bearings, worn couplings, vibration and a possible failure of the pump, the following points shall be strictly followed:

- a) Prevent excessive external pipe load.
- b) Do not connect piping by applying external force (use of wrenches, crane,...). Piping shall be aligned without residual stress.
- c) Do not mount expansion joints so that their force, due to internal pressure, acts on the pump flange.

Fitting an isolator and non-return valve can allow easier maintenance.

A non-return valve shall be located in the discharge pipework to protect the pump from excessive back pressure and hence reverse rotation when the unit is stopped.



If sludge can build up in the sump it is recommended to use a strainer with a maximum opening size of 6 mm (0.024 in.) and a free surface area greater than three times the pump suction area.

Piping for corrosive liquids shall be arranged to allow pump flushing before removal of a unit.

### 4.5.2 External Lubrication

An external lubrication system with clean fluid is required, if the pumpage is not suitable to flush the line bearings. The necessary connection is provided at the baseplate and shown on the General Arrangement drawing.

**Note:** The external flushing system is not scope of Flowserve's supply.

### 4.5.3 Internal Lubrication with Inline Filter

An inline filter is required, if the pumpage contents solids and no clean fluid for external line bearing flushing is available. Refer to General Arrangement Drawing for the piping arrangement.

**Note:** The minimum pressure in the lubrication system is 2 bar (29 psi) above suction pressure. If pressure is lower, the filter must be cleaned by flushing.

### 4.6 Electrical connections



Electrical connections must be made by a qualified Electrician in accordance with the relevant local national and international regulations.



It is important to be aware of the EUROPEAN DIRECTIVE on hazardous areas where compliance with IEC60079-14 is an additional requirement for making electrical connections.



It is important to be aware of the EUROPEAN DIRECTIVE on electromagnetic compatibility when wiring up and installing equipment on site. Attention must be paid to ensure that the techniques used during wiring/installation do not increase electromagnetic emissions or decrease the electromagnetic immunity of the equipment, wiring or any connected devices. If in any doubt contact Flowserve for advice.



The motor must be wired up in accordance with the motor manufacturer's instructions (normally supplied within the terminal box) including any temperature, earth leakage, current and other protective devices as appropriate. The identification nameplate should be checked to ensure the power supply is appropriate.



A device to provide emergency stopping must be fitted.

If not supplied pre-wired to the pump unit the controller/starter electrical details will also be supplied within the controller/starter.

For electrical details on pump sets with controllers see the separate wiring diagram.



See section 5.4, *Direction of rotation* before connecting the motor to the electrical supply.

### 4.7 Final shaft alignment check

After connecting piping to the pump, rotate the shaft several times by hand to ensure there is no seizure and all parts are free.

Recheck the coupling alignment, as previously described, to ensure no pipe strain. If pipe strain exists, correct piping.

### 4.8 Protection systems



The following protection systems are recommended particularly if the pump is installed in a hazardous environment or is handling a hazardous liquid. If in doubt consult Flowserve.

If there is any possibility of the system allowing the pump to run against a closed valve or below minimum continuous safe flow a protection device should be installed to ensure the temperature of the liquid does not rise to an unsafe level.

If there are any circumstances in which the system can allow the pump to run dry, or start up empty, a power monitor should be fitted to stop the pump or prevent it from being started. This is particularly relevant if the pump is handling a flammable liquid.

If leakage of product from the pump or its associated sealing system can cause a hazard. It is recommended that an appropriate leakage detection system is installed.

To prevent excessive surface temperatures at bearings it is recommended that temperature or vibration monitoring are carried out.

## 5.0 COMMISSIONING START-UP, OPERATION AND SHUTDOWN



*These operations must be carried out by fully qualified personnel.*

### 5.1 Precommissioning procedure

- a) The bearing housing must be filled with the indicated oil. Check also the oil level.
- b) If required open the external lubrication line (refer to section 4.5.2, External *Lubrication System*), to ensure proper lubrication of the line bearings for start up. It can be closed after start up.
- c) If applicable heat jackets must be flushed by steam prior to start up. Required steam properties are shown on the General Arrangement drawing.
- d) Check the sense of rotation of the pump (Coupling spacer dismantled). Sense of rotation is clockwise viewed to the drive end of the pump.
- e) The pump rotor and the shaft seal must be in correct axial position. Mounting plates of mechanical seal must be locked at the seal gland in open position. Drive-collar of the mechanical seal sleeve must be tightened. If the pump is equipped with a soft packing, ensure that the packing is prelubricated with grease.
- f) Check the readiness of all auxiliary systems (seal sys., lubrication sys.,...) for start up.
- g) All pipe work, including the internal and the auxiliary pipe work, must be connected correctly and must be absolutely tight. Check the tightness of all connections of the auxiliary pipe work. The suction valve must be open, the discharge valve shall be closed.
- h) Turn the pump by hand, if required with the help of a lever, to check the free rotation of the rotor. The rotor must turn uniformly and noiselessly. Some resistance may be felt due to friction in bearings and seals.
- i) Check the readiness of the driver for start up. Refer to the manual of the driver (preheating for explosion proof E-motor).

### 5.2 Pump Lubricants

#### 5.2.1 Lubrication

The bearing housing shall be filled with proper lubricating oil prior to start up. If the pump will be started after a longer storage period, the bearing housing should be first flushed and cleaned with gasoline. It is not necessary to remove the preservation oil as this will mix up thoroughly with the lubrication oil.

Lubrication is provided by the pumping effect of the rotating ball bearings. Maintaining the correct oil level

(middle of the oil sight glass) ensures that the lower ball bearing is covered with oil.

As option a ¼" NPT connection for a purge oil mist lubrication is provided (refer to General Arrangement Drawing).

For recommended lubricating oils refer to the lubrication table 5.2.6

#### 5.2.2 Purge oil mist lubrication

For preventing, that dirt or humidity get into the bearing housing, this pump is equipped with a ¼" NPT connection for air or nitrogen supply.

Also at standstill the air or nitrogen supply shall be maintained.



The pressure shall be between **0.01 bar (0.14 psi) and 0.02 bar (0.29 psi)**, otherwise you have to consider an oil leakage and as a result a bearing damage .

The provided flow rate shall be 0,1 SCFM.

The supplied air or nitrogen shall be clean and dry.

#### 5.2.3 Oil change

After first start up, the oil shall be changed after 200 service hours.

Every further oil change shall take place after about 2000 service hours or at least every 6 month.

#### 5.2.4 Oil level

The correct oil level is in the middle of the oil sight glass and shall be checked when pump is not in operation. Periodically check if the lubricating oil is mixed with any condensed water. Careful opening of the oil drain during a stop of the pump will show any water.

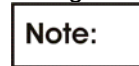

During operation the level will decrease due to circulation of the oil through the bearings.



A too high oil level will result in higher bearing temperatures and therefore poorer lubrication.

#### 5.2.4.1 Adjusting of WATCHDOG Constant Level Oiler

This design of Watchdog Oiler prevents the flooding of the bearing by means of the positive setting in the Oiler, thus maintaining the correct oil level at all times. When these Oilers are used on Ball or Roller bearings, the installation is the same as described below, excepting that the oil level in the bearing should never cover more than maximum above inside diameter of the outer race at its lowest point.

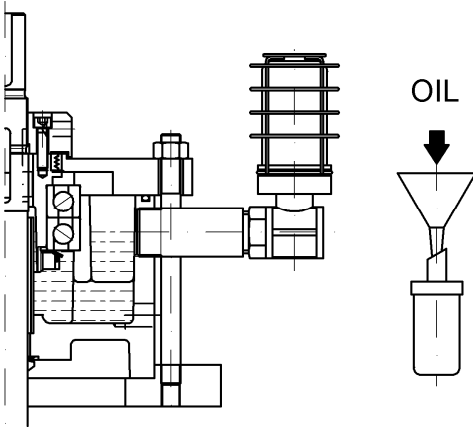

Frame.	Oil quantity l (Fl.oz.)	Bearing size
1	0.5 (16.9)	7210 BECBJ
2	0.6 (20.3)	7213 BECBJ
3	0.7 (23.7)	7215 BECBJ
4	1.4 (47.3)	7218 BECBJ

**Note:** If the pump is fitted with a Constant Level Oiler type "WATCHDOG", no adjustment of the oil level is possible.

**5.2.5 Oil quality**

Oil used for lubrication should only be of high quality. The viscosity of the oil at working temperature must be at least 10 cSt. The pouring point of the oil must be in accordance with the lowest expected temperature of the bearing housing during a stop of the pump. For recommended lubricating oils refer to the lubrication table.

Having selected the corresponding oil quality the actual oil temperature at the bearing housing must be checked after two service hours of the pump. Considering this measured oil temperature the actual viscosity must be determined by using the data sheet of the oil, to verify the minimum required viscosity of 10 cSt. Do not forget, the oil temperature in the bearing itself is about 10 °C (50 °F) higher than the oil temperature at the bearing housing. On the following table the oil viscosity is given at 40 °C (104 °F). Determining the correct lubricating oil one must take into consideration that all bearings will have higher temperatures during the first 20 service hours. In constant operation the bearing temperature will decrease about 10 °C (50 °F). The oil temperature shall be lower than 85 °C (185 °F) after this running-in time. The bearing outer race temperature should not exceed 95°C (204°F). If the temperature is higher, the reason may be a wrong oil quality, wrong oil level or overload of the pump because of excessive wear. If the humidity at the site is high, the roller bearings become easily rusty during stand still periods. To avoid that, we recommend to mix the lubricating oil with a corrosion inhibitor contact your lubrication oil supplier for proper additives inhibitors.

**5.2.6 Oil quantity**

Bearing size is shown on the name plate of the pump, and with this the correct thrust bearing frame can be selected according to the following table.

5.2.7 Lubrication Table

Oil lubrication / Recommendation						
Bearing temp.	+40 °C - +70 °C (+104 °F - +158 °F)		+70 °C - +100 °C (+158 °F - +212 °F)		+100 °C - +120 °C (+212 °F - +248 °F)	
Ambient temp.	-5 °C - +40 °C (-23 °F - +104 °F)		-5 °C - +40 °C (-23 °F - +104 °F)		-5 °C - +40 °C (-23 °F - +104 °F)	
<b>Mobil</b>	MOBIL SHC 624(synthetic) MOBIL DTE 24	32,4 <sup>1</sup> 31 <sup>1</sup>	Mobil DTE 27	95 <sup>1</sup>	Mobil SHC 629 ( synthetic)	143 <sup>1</sup>
<b>BP</b>	Energol HLP-HM 32 Energol HLP-HM 46	32 <sup>1</sup> 46 <sup>1</sup>	Energol HLP-HM 100			
<b>Shell</b>	Shell Turbo T 46	49 <sup>1</sup>	Shell Turbo T 100	100 <sup>1</sup>	Shell Morlina 220	220 <sup>1</sup>
<b>Esso</b>	TERESSO 32 TERESSO 46	30 <sup>1</sup> 43 <sup>1</sup>	NUTO H 100 NUTO H 150	100 <sup>1</sup> 150 <sup>1</sup>	SPARTAN EP 220	220 <sup>1</sup>
<b>Castrol</b>	Hyspin AWS 32	32 <sup>1</sup>	Alpha SP 100	100 <sup>1</sup>	Alpha SP 220 Alphasyn T 150 ( synthetic)	220 <sup>1</sup> 150 <sup>1</sup>
<b>OMV</b>	OMV turb HTU 46	46 <sup>1</sup>	OMV gear HST 100	97,8 <sup>1</sup>	OMV gear HST 220	226 <sup>1</sup>
<b>Aral</b>	Aral Degol BG 46 Aral Vitam GF 46	46 <sup>1</sup> 46 <sup>1</sup>	Aral Degol BG 100	100 <sup>1</sup>		

For temperatures below -5 °C (-23 °F) use lubrication oil class SAE 5W-50 or API-SJ.

	Seal System / Pumped Liquid	Quench-Oil	General Features
<b>Barrier/Buffer Fluid for Mech. Seal</b>	Tandem Seal to -40 °C (-40 °F) Back to back Seal with gascoffer-dam Conventional back to back Seal	- Refined Hydraulic Oil - Synthetic Oil - Mixture of water / glykol  <b>ATTENTION:</b> <u>Do not use Methanol</u>	appr. 10-15 cSt at 40°C (104 °F)  below -40°C (-40 °F) Pourpoint vaporization above 80°C (176 °F)
	Tandem Seal to -60°C (-76 °F)	Ethanol/Propanol	

The sequence of the suppliers of the lubricants does not represent any indication of their superiority.

<sup>1</sup> Viscosity at 40 °C (104 °F) in cSt [mm<sup>2</sup>/s] DIN 51562

### 5.3 Impeller clearance

Correct axial rotor setting is essential for trouble free operation of the pump.

#### 5.3.1 Adjusting of the rotor

- 1) Remove coupling spacer, coupling hub on pump shaft and vane [8161.2] (when delivered).
- 2) Fix the position of the mechanical seal by putting the assembly jigs, mounted on the seal end plate, into the groove in the shaft sleeve.

**Note:**

No requirements for softpacking, V-ring or throttle bushing.

- 3) Open screws from the clamping unit, located on the end of the shaft sleeve (refer to shaft seal drawing).
- 4) Loose and remove socket head cap screws [6579.1] from the shaft nut [2910].
- 5) Turn shaft nut upside till the rotor moves in the lowest position and cannot turned by hand.
- 6) Measure the dimension from the shaft nut to the end of the shaft.
- 7) Now lift the rotor by turning the shaft nut in the other direction till it is in the highest position.

**Note:**

For heavy pumps (rotor weight > 150 kg (331 lb.)) we recommend the following practice. The rotor is already in its lowest position. Screw in an Eyebolt into the thread at the top of the shaft. Use a lever or a crane to lift the shaft (do it slowly, the axial clearance is only a few millimetres).

- 8) Measure again the dimension from the shaft nut to the end of the shaft.
- 9) For closed impeller with back wear rings (Type R) take the mean value of the two dimensions and adjust the rotor to this value by turning the shaft nut.

For standard semi open or standard free flow impeller (Type O,F) adjust the rotor to 0.7 mm (0.03 in.) of its highest position.

**Note:**

The type of hydraulic is shown on the nameplate (refer to section 3.2 *Nomenclature*)

- 10) Fix the shaft nut with the socket head cap screws.

**Note:**

Turn the shaftnut always in downwards direction to meet the whole for the socket head cap screw.

- 11) Fix the shaft sleeve with the clamping unit and turn the assembling jigs out of the groove from the shaft sleeve and fix them on the seal end plate.
- 12) Check if the shaft can be turned easy by hand
- 13) Mount fan (when delivered) coupling hub and spacer again.

### 5.4 Direction of rotation



The sense of rotation of the pump is clockwise (CW); looking from the coupling to the shaft end of the pump.



The rotation of the driver shall be checked.

### 5.5 Guarding

Be sure that the coupling guards are mounted correctly at the thrust motor stool prior to start up.

### 5.6 Priming and auxiliary supplies

Ensure that the minimum liquid level is maintained.

**Note:**

The minimum liquid level is shown on the General Arrangement Drawing.

Open external flushing line, if provided. (refer to section 4.5.2 *External Lubrication*.)

Auxiliary systems, e.g. barrier /buffer fluid systems, cooling circuits, shall be filled according to the user instructions.

### 5.7 Starting the pump

- a) Start the driver according to the specification. (Refer to driver IOM)

**Note:**

Pumps are usually started against closed discharge valve

- b) Check the discharge and suction pressure gauge to verify the pumps delivered head. If pump is equipped with external flushing or inline filter (refer to chapter 4.5.2, 4.5.3) Check the pressure gauge in the flushing line. Open the discharge valve slowly, until the pump reaches the specified operation point. The pump must operate smoothly, and the vibration must be below 5 mm/s (0.2 in./sec) (API 610 vibration limits).



The discharge valve must be opened within 30 sec. after start up. Longer operation against closed discharge valve will damage the pump. If a minimum flow valve is installed, take pressure gauge readings to verify the correct operation.

**Note:**

If the backpressure of the discharge pipe is sufficient, pumps can be started against open valve.



Ensure that your driver is capable deliver the higher torque required by starting against open valve.



To prevent the pump from reverse rotation after shut down, the installation of a check valve is recommended.

Although the pump is not affected by reverse rotation because of special coupling design, it can be an issue with the driver.

Check the discharge and suction pressure gauge to verify the pumps delivered head.

The pump must operate smoothly, and the vibration must be below 5 mm/s (0.2 in./sec) (API 610 vibration limits).

If a minimum flow valve is installed, take pressure gauge readings to verify the correct operation.

- c) Check the pipe system against any leakage.
- d) Check the mechanical seal against any leakage.

**Note:**

There is no fluid at the seal by ECPJ pumps. Only the barrier liquid can leak against the atmosphere. Right after start up a minor leakage of the mechanical seal is quite normal. Normally this leakage disappears after few minutes of operation.

**5.8 Operation**

- a) Verify that the pump is operating within the specified limits, min/max flow, pressure, temperature, vibration, power
- b) The bearing housing temperature shall not exceed 80 °C (176 °F). If higher bearing temperature are observed, check the viscosity grade of the used lubrication oil.



The minimum viscosity is 10 cSt at the expected oil temperature. (Oil temperature = bearing gland temperature + 10 °C (50 °F))

- c) From time to time check the pump shaft seal. Leakage of 5 ml/hour is also with a mechanical shaft seal unavoidable.

**Note:**

If pump is equipped with soft packing, maintain regreasing intervals.

- d) Observe the power consumption of the pump to detect excessive wear.

**5.8.1 Normal vibration levels, alarm and trip**

For guidance, pumps generally fall under a classification for rigid support machines within the International rotating machinery standards and the recommended maximum levels below are based on those standards.



Alarm and trip values for installed pumps should be based on the actual measurements (N) taken on the pump in the fully commissioned as new condition.



Regular monitoring of the pump vibration is recommended to show any deterioration in pump or

system operating conditions. The vibration is measured adjacent to the pump thrust bearing. For remote installations continuous monitoring and automatic alert and shutdown is recommended.

Vibration velocity – unfiltered mm/sec (in./sec) r.m.s.		
Normal	<b>N</b>	≤ 3.4 (0.14)
Alarm	<b>N x 1.25</b>	≤ 4.25 (0.17)
Shutdown trip	<b>N x 2.0</b>	≤ 6.8 (0.27)

**5.9 Stopping and Shutdown**

- a) Close the outlet valve, but ensure that the pump runs in this condition for no more than a few seconds.
- b) Stop the pump.
- c) Switch off flushing and/or cooling/ heating liquid supplies at a time appropriate to the process.
- d) For prolonged shut-downs and especially when ambient temperatures are likely to drop below freezing point, the pump and any cooling and flushing arrangements must be drained or otherwise protected.

**Note:**

For automatic start/stop operation of the pump, ensure that all steps described in chapter 5.6, 5.7, 5.8 and 5.9 are implemented in the control logic.

**5.10 Hydraulic, mechanical and electrical duty**

This product has been supplied to meet the performance specifications of your purchase order, however it is understood that during the life of the product these may change. The following notes will help the user to decide how to evaluate the implications of any change. If in doubt contact your nearest Flowserve office.

**5.10.1 Specific gravity (SG)**

Pump capacity and total head in meters (feet) do not change with SG, however pressure displayed on a pressure gauge is directly proportional to SG. Power absorbed is also directly proportional to SG. It is therefore important to check that any change in SG will not overload the pump driver or over-pressurize the pump.

**5.10.2 Viscosity**

For a given flow rate the total head reduces with increased viscosity and increases with reduced viscosity. Also for a given flow rate the power absorbed increases with increased viscosity, and reduces with reduced viscosity. It is important that checks are made with your nearest Flowserve office if changes in viscosity are planned.

**5.10.3 Pump speed**

Changing pump speed effects flow, total head, power absorbed, NPSHR, noise and vibration. Flow varies

in direct proportion to pump speed. Head varies as speed ratio squared. Power varies as speed ratio cubed. If increasing speed it is important therefore to ensure the maximum pump working pressure is not exceeded, the driver is not overloaded, NPSHA > NPSHR, and that noise and vibration are within local requirements and regulations.

**5.10.4 Net positive suction head (NPSHA)**

NPSH available (NPSHA.) is a measure of the energy available in the pumped liquid, above its vapour pressure, at the pump suction branch. NPSH required (NPSHR.) - is a measure of the energy required in the pumped liquid, above its vapour pressure, to prevent the pump from cavitating. It is important that NPSHA > NPSHR. The margin between NPSHA > NPSHR should be as large as possible. If any change in NPSHA is proposed, ensure these margins are not significantly eroded. Refer to the pump performance curve to determine exact requirements particularly if flow has changed. If in doubt please consult your nearest Flowserve office for advice and details of the minimum allowable margin for your application.

**5.10.5 Pumped flow**

Flow must not fall outside the minimum and maximum continuous safe flow shown on the pump performance curve and/or data sheet.

**6.0 MAINTENANCE**

**6.1 General**



It is the plant operator's responsibility to ensure that all maintenance, inspection and assembly work is carried out by authorized and qualified personnel who have adequately familiarized themselves with the subject matter by studying this manual in detail. (See also section 1.6.2.)

Any work on the machine must be performed when it is at a standstill. It is imperative that the procedure for shutting down the machine is followed, as described in section 5.9.

On completion of work all guards and safety devices must be re-installed and made operative again.

Before restarting the machine, the relevant instructions listed in section 5, *Commissioning, start up, operation and shut down* must be observed.

**Oil and grease leaks may make the ground slippery. Machine maintenance must always**

***begin and finish by cleaning the ground and the exterior of the machine.***

If platforms, stairs and guard rails are required for maintenance, they must be placed for easy access to areas where maintenance and inspection are to be carried out. The positioning of these accessories must not limit access or hinder the lifting of the part to be serviced.

When air or compressed inert gas is used in the maintenance process, the operator and anyone in the vicinity must be careful and have the appropriate protection.

Do not spray air or compressed inert gas on skin.

Do not direct an air or gas jet towards other people.

Never use air or compressed inert gas to clean clothes.

Before working on the pump, take measures to prevent an uncontrolled start. Put a warning board on the starting device with the words: **"Machine under repair: do not start"**.

With electric drive equipment, lock the main switch open and withdraw any fuses. Put a warning board on the fuse box or main switch with the words: **"Machine under repair: do not connect"**.

Never clean equipment with inflammable solvents or carbon tetrachloride. Protect yourself against toxic fumes when using cleaning agents.

**6.2 Maintenance schedule**



It is recommended that a maintenance plan and schedule is adopted, in line with these User Instructions, to include the following:

- a) Any auxiliary systems installed must be monitored, if necessary, to ensure they function correctly.
- b) Gland packings must be adjusted correctly to give visible leakage and concentric alignment of the gland follower to prevent excessive temperature of the packing or follower.
- c) Check for any leaks from gaskets and seals. The correct functioning of the shaft seal must be checked regularly.
- d) Check bearing lubricant level, and if the hours run show a lubricant change is required.
- e) Check that the duty condition is in the safe operating range for the pump.
- f) Check vibration, noise level and surface temperature at the bearings to confirm satisfactory operation.



- g) Check dirt and dust is removed from areas around close clearances, bearing housings and motors.
- h) Check coupling alignment and re-align if necessary.

Our specialist service personnel can help with preventative maintenance records and provide condition monitoring for temperature and vibration to identify the onset of potential problems.

If any problems are found the following sequence of actions should take place:

- a) Refer to section 8, *Faults; causes and remedies*, for fault diagnosis.
- b) Ensure equipment complies with the recommendations in this manual.
- c) Contact Flowserve if the problem persists.

**6.2.1 Routine Inspection (daily/weekly)**



The following checks should be made and the appropriate action taken to remedy any deviations.

- a) Check operating behavior; ensure noise, vibration and bearing temperatures are normal.
- b) Check that there are no abnormal fluid or lubricant leaks (static and dynamic seals) and that any sealant systems (if fitted) are full and operating normally.
- c) Check that shaft seal leaks are within acceptable limits.
- d) Check the level and condition of lubrication oil. On grease lubricated pumps, check running hours since last recharge of grease or complete grease change.
- e) Check any auxiliary supplies eg. heating/cooling (if fitted) are operating correctly.
- f) Refer to the manuals of any associated equipment if routine checks needed.

**6.2.2 Periodic Inspection (every 6 Month)**



- a) Check foundation bolts for security of attachment and corrosion.
- b) Check pump operation hours to determine if bearing lubricant shall be changed.
- c) The coupling should be checked for correct alignment and worn driving elements.



Refer to the manuals of any associated equipment for periodic checks needed.

**6.3 Spare parts**

**6.3.1 Ordering of spares**

When ordering spare parts we need the following information:

1. pump type and pump size
2. serial number of the pump
3. number of the required spare parts
4. reference number and name of the part as listed in the part list or in the sectional drawing

Example: for Vertical, single stage, sump pump:

ECPJ 32-250, serial number G202222/01  
1 piece impeller Pos. 2200

The serial number of each pump is indicated on the name plate. If the material should be changed from the original delivered one, additionally indicate the exact material specification. If ordered impellers shall have smaller or larger outer diameter, indicate also with your order. Without a special remark the spare impellers will be delivered with the diameter of the original impellers.

If you need the wear rings oversized or undersized, please indicate, otherwise the wear rings will be delivered with standard size.

To ensure continuous satisfactory operation, replacement parts to the original design specification should be obtained from Flowserve.

Any change to the original design specification (modification or use of a non-standard parts) will invalidate the pump's safety certification.

**6.3.2 Storage of spares**

Spares should be stored in a clean dry area away from vibration. Inspection and retreatment of metallic surfaces (if necessary) with preservative is recommended at a 6 monthly interval.

### 6.4 Recommended spares

Part	Spares Recommended						
	Start up			Normal Maintenance			
No. of identical pumps	1 - 3	4 - 6	7+	1 - 3	4 - 6	7 - 9	10+
Element (if unspared) (1)				1	1	1	1
Rotor				1	1	1	1
Case							1
Head (case cover and stuffing box)							1
Motor stool							1
Shaft (w/key)				1	1	2	1
Impeller				1	1	2	3
Wear rings (set)	1	1	1	1	1	2	3
Bearings complete (antifriction, radial)	1	2	3	1	2	3	3
Bearings complete (antifriction, thrust)	1	2	3	1	2	3	3
Bearing pads only (hydrodynamic, thrust)	1	1	1	1	1	1	5
Mechanical seal complete (Cartridge)	1	2	3	1	2	3	3
Shaft sleeve	1	2	3	1	2	3	3
Gaskets, O-rings (set)	1	2	3	1	2	3	3
Bearing bushings and sleeves (set)	1	1	2	1	1	3	3

(1) Vital service pumps are generally unspared, partially spared or multistage. When a vital machine is down, production loss or violation of environmental permits results. Element consist of assembled rotor plus stationary hydraulic parts (diffuser(s) or volute(s)).

### 6.5 Fastener torques

Tightening torque M <sub>A</sub> Nm (lbf.ft)					
Size of screw	Duplex SS (S32760, S31803, 1.4462)	Carbon Steel (NACE) (A 193 Gr. B7M, A 320 Gr. L7M)	Carbon Steel (A 193 Gr. B7, A 320 Gr. L7, 8.8)	Austenitic SS (A 193Gr. B8MA) (NACE)	Austenitic SS (A 193 Gr. B8/B8M, A4-70,A2-70)
M 4	2 (1,5)	2,4 (1,8)	2,8 (2,1)	0,9 (0,7)	2 (1,5)
M 5	3,9 (2,9)	4,8 (3,6)	5,6 (4,1)	1,8 (1,4)	3,9 (2,9)
M 6	6,8 (5)	8,3 (6,1)	9,7 (7,1)	3,2 (2,3)	6,8 (5)
M 8	16,2 (12)	19,8 (14,6)	23,1 (17)	7,6 (5,6)	16,2 (12)
M 10	31,9 (23,6)	39 (28,8)	45,4 (33,5)	14,9 (11)	31,9 (23,6)
M 12	55,4 (40,9)	67,8 (50)	78,8 (58,2)	25,9 (19,1)	55,4 (40,9)
M 14	87,9 (64,9)	107,5 (79,3)	125,1 (92,3)	41 (30,3)	87,9 (64,9)
M 16	134,6 (99,3)	164,5 (121,4)	191,4 (141,3)	62,8 (46,4)	134,6 (99,3)
M 18	188 (139)	230 (170)	267 (197)	88 (65)	188 (139)
M 20	263 (194)	321 (237)	373 (276)	123 (90)	263 (194)
M 22	353 (260)	431 (318)	502 (370)	165 (121)	196 (145)
M 24	453 (334)	553 (408)	644 (475)	211 (156)	251 (186)
M 27	654 (483)	799 (590)	930 (686)	305 (225)	363 (268)
M 30	892 (658)	1090 (805)	1269 (936)	416 (307)	496 (366)
M 33	1200 (886)	1467 (1082)	1707 (1260)	560 (413)	667 (492)
M 36	1550 (1144)	1895 (1398)	2205 (1627)	723 (534)	861 (636)
M 39	1988 (1467)	2430 (1793)	2827 (2086)	928 (685)	1104 (815)
M 42	2472 (1824)	3021 (2229)	3515 (2594)	1153 (851)	1373 (1013)
M 45	3061 (2259)	3741 (2761)	4354 (3213)	1429 (1054)	1701 (1255)
M48	3703 (2732)	4526 (3340)	5266 (3886)	1728 (1275)	2057 (1518)
M64	8862 (6539)	10831 (7993)	12604 (9301)	4136 (3052)	4923 (3633)

Above mentioned torques are for all screwed unions, which works under dynamical load. For all other connections you can use a corresponding smaller torque.

## 6.6 Setting impeller clearance

For axial rotor setting see section 5 *Commissioning startup, operation and shutdown*.

## 6.7 Disassembly



Refer to section 1.6, *Safety*, before dismantling the pump.



Before dismantling the pump for overhaul, ensure genuine Flowserve replacement parts are available. Refer to sectional drawings for part numbers and identification.

### 6.7.1 Dismantling

- 1) If the pump is mounted on a tank, ensure that explosive or toxic gases are drained completely. By pumping explosive or toxic media, flush the tank with Nitrogen.
- 2) Uncouple the pump from the motor and remove the motor after disconnecting it from the electrical net.
- 3) Pull off the coupling hub from the top shaft [2130.1] and take out the key.[6700.1].
- 4) Secure the mechanical seal by putting the mounting plates [5062] into the groove of the shaft sleeve [2450]. Loose the clamping ring [2544], and disconnect the seal piping.



Drain the seal system, if applicable.

- 5) Drain the oil from the bearing housing using the plug [6569]. Loose the bolts [6577.10] and pull out the pump from the pit or tank.
- 6) Loose the socket head cap screw [6579.1] and slip down the rotor by turning the shaft nut [2910] and remove it.

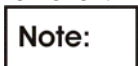

If applicable pull off the vane [8161.2] after loosening the socket set screw [6577.11].



If the pump is equipped with a rigid spacer coupling open the socket head cap screws [6579.3] at the top shaft [2130.2] and [2130.1]. Push up the top shaft [2130.2] and remove the intermediate coupling [7021]. To pull off the coupling hubs, open the socket head cap screws [6579.4] and remove the retaining ring [2530].

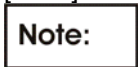

Take care of the lock washer [4357]. Now open the socket head cap screws [6579.4] to remove the spacer. Push up the coupling half [7200] on the top shaft [2130.2] to remove the retaining ring [2530]. Now you can pull off the coupling hub.

- 7) Loose the stud [6572.1], take off the bearing cover [3260.1] and remove key [6700.2]. Pull off the bearing housing [3200]. Loose the stud [6572.2] and pull off the mechanical seal cartridge.
- 8) Remove the suction hose [9223] by opening the hexagon head bolt [6577.6].
- 9) Disconnect the lubricating line [3840] from all line bearing locations and the discharge elbow [1371].
- 10) Open the hexagon head bolts [6577.7] to disconnect the pump casing [1110] from the discharge pipe and discharge elbow [1360, 1371].
- 11) Loose the hex nuts [6581.7] of the studs [6572.4] to pull off the pump casing [1110].
- 12) Unsecure the lockwasher [6541.2] and loose the impeller nut [2912]. Now you can pull off the impeller [2200] and take out the key [6700.5].
- 13) Pull off the casing cover [1221] with the bearing bushing [3300.1].
- 14) Loose the hexagon head bolt [6577.4] and remove the intermediate pipe [1341.3]. Pull off the bearing support [3250] together with the bearing bushing [3300.2].

#### Note:

If required by bearing bushing material, the bushing is secured by a cylindrical pin [6811.1]. (refer to Sectional Drawing)

- 15) Unsecure the shaft coupling [7020] by loosening the hexagon head bolt [6577.5]. Slide up the shaft coupling [7020] and take out the coupling shell split [7240]. Now you can remove the pump shaft [2110].

#### Note:

Take care of the keys [6700.4].

- 16) To disassemble the following intermediate shafts repeat step 14 and 15.

#### Note:

The intermediate shaft is not necessarily coupled at each bearing location (refer to Sectional Drawing).

- 17) To disconnect the upper intermediate pipe [1341.1] from the support plate [6140] loose the hex nuts [6581.3] and pull off the motor stool [3160] and bearing lantern [3140].

#### Note:

Item [3140] is only provided with rigid coupling arrangement.

### 6.7.2 Dismantling – Heat jacket version

- 1) If the pump is mounted on a tank, ensure that explosive or toxic gases are drained completely. By pumping explosive or toxic media, flush the tank with Nitrogen. Additionally drain the heating jacket and disconnect the supply lines.
- 2) Uncouple the pump from the motor and remove the motor after disconnecting it from the electrical net.
- 3) Pull off the coupling hub from the top shaft [2130.1] and take out the key [6700.1].

- 4) If applicable secure the mechanical seal by putting the mounting plates [9310] into the groove of the shaft sleeve [2450]. Loose the clamping ring [2544], and disconnect the seal piping.



Drain the seal system, if applicable.

- 5) Drain the oil from the bearing housing using the plug [6569]. Loose the bolts [6577.10] and pull out the pump from the pit or tank.
- 6) Loose the socket head cap screw [6579.1] and slip down the rotor by turning the shaft nut [2910] and remove it.

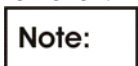

If applicable pull off the fan [8161.2] after loosening the socket set screw [6577.11].

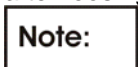

If the pump is equipped with a rigid spacer coupling open the socket head cap screw [6579.3] at the top shaft [2130.2] and [2130.1]. Push up the top shaft [2130.2] and remove the intermediate coupling [7021]. To pull off the coupling hubs, open the socket head cap screws [6579.4] and remove the retaining rings [2530].

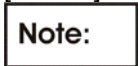

Take care of the clamping ring [2542].

Now open the socket head cap screws [6579.4] to remove the spacer. Push up the coupling half [7200] on the top shaft [2130.2] to remove the retaining ring [2530]. Now you can pull off the coupling hub.

- 7) Loose the studs [6572.6], take off the bearing cover [3260.1] and remove key [6700.2]. Pull off the motor stool [3160]. Loose the studs [6572.2] and pull off the mechanical seal cartridge.
- 8) Remove the suction hose [9223] by opening the hexagon head bolt [6577.6].
- 9) Disconnect the steam pipes from the column pipes and the discharge pipe.
- 10) Open the hexagon head bolts [6577.7] to disconnect the pump casing [1110] from the discharge pipe and elbow [1371, 1360]
- 11) Loose the hex nuts [6581.7] of the studs [6572.4] to pull off the pump casing [1110].
- 12) Unsecure the lockwasher [6541.2] and loose the impeller nut [2912]. Now you can pull off the impeller [2200] and take out the key [6700.5].
- 13) Pull off the casing cover [1221] with the bearing bushing [3300.1].
- 14) Loose the hexagon head bolts [6577.4] and remove the intermediate pipe [1341.3]. Pull off the bearing support [3250] together with the bearing bushing [3300.2].

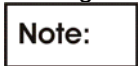

If required by bearing bushing material, the bushing is secured by a cylindrical pin [6811.1] (refer to Sectional Drawing).

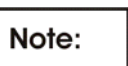

Replace gasket [4590.6] at bearing spider after each disassembly.

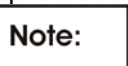

Drain the steam condensate from the discharge pipe heat jacket.

- 15) Unsecure the shaft coupling [7020] by loosening the hexagon head bolt [6577.5]. Slide up the shaft coupling [7020] and take out the coupling shell splits [7240]. Now you can remove the pump shaft [2110].

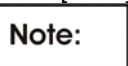

Take care of the keys [6700.4].

- 16) To disassemble the following line shafts repeat step 14 and 15.

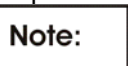

The line shaft is not necessarily coupled at each bearing location (refer to Sectional Drawing).

- 17) To disconnect the upper intermediate pipe [1341.1] from the support plate [6140] loose the hex nuts [6581.3] and pull off the motor stool and bearing lantern [3160, 3140].

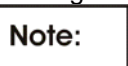

Item [3140] is only provided with rigid coupling arrangement.

### 6.7.3 Dismantling of the thrust bearing

Frame	Bearing size
1	7210 BECBJ
2	7213 BECBJ
3	7215 BECBJ
4	7218 BECBJ

#### 6.7.3.1 Bearing housing

- 1) Remove the bearing assembly consisting of the thrust ball bearing [3013], bearing adaptor sleeve [2471] and the bearing lock nut [3712] as a cartridge.
- 2) Open the bearing lock nut [3712] and pull off the thrust ball bearing [3013]

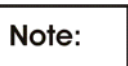

Take care about the labyrinth ring [4330.1].

### 6.8 Examination of parts

- 1) Check the line bearing sleeves and bushings against any wear. The diametrical clearance between sleeves and bushings must not exceed twice the value in new condition.
- 2) Check the casing wear ring and the impeller wear ring against any wear. The diametrical clearance between the rings must not exceed twice the value in new condition.
- 3) Check all parts against corrosion and erosion.
- 4) Carefully check the coupling against any wear.

- 5) Rotate the angular contact bearing by hand, to check against abnormal sound. Check the bearing cages against any wear and the outer and inner race against running marks. Check the runout of the shafts. TIR (Total Indicated Runout) shall not exceed 0.04 mm/m (0.0005 in./ft) of length. TIR shall not exceed 0.08 mm (0.003 in.) over total shaft length.

Pump size	Wear ring diameter mm (in.)	Radial clearances mm (in.)	
FRAME 1	25-125	78 (3.1)	0.3 (0.012)
	25-160	78 (3.1)	0.3 (0.012)
	25-200	78 (3.1)	0.3 (0.012)
	32-125	78 (3.1)	0.3 (0.012)
	32-160	78 (3.1)	0.3 (0.012)
	32-200	78 (3.1)	0.3 (0.012)
	40-125	90 (3.5)	0.3 (0.012)
	40-160	90 (3.5)	0.3 (0.012)
	40-200	105 (4.1)	0.3 (0.012)
	50-125	95 (3.7)	0.3 (0.012)
	50-160	105 (4.1)	0.3 (0.012)
	50-200	105 (4.1)	0.3 (0.012)
FRAME 2	65-125	114 (4.5)	0.3 (0.012)
	32-250	90 (3.5)	0.3 (0.012)
	40-250	105 (4.1)	0.3 (0.012)
	50-250	105 (4.1)	0.3 (0.012)
	65-160	138 (5.4)	0.35 (0.014)
	65-200	138 (5.4)	0.35 (0.014)
	65-250	138 (5.4)	0.35 (0.014)
	80-160	138 (5.4)	0.35 (0.014)
FRAME 3	80-200	169 (6.7)	0.35 (0.014)
	100-200	169 (6.7)	0.35 (0.014)
	40-315	105 (4.1)	0.3 (0.012)
	50-315	124 (4.9)	0.35 (0.014)
	65-315	138 (5.4)	0.35 (0.014)
	80-250	138 (5.4)	0.35 (0.014)
	80-315	169 (6.7)	0.35 (0.014)
	80-404	169 (6.7)	0.35 (0.014)
	100-250	169 (6.7)	0.35 (0.014)
	100-315	169 (6.7)	0.35 (0.014)
	100-400	184 (7.2)	0.35 (0.014)
	125-250	179 (7.1)	0.35 (0.014)
FRAME 4	125-315	184 (7.2)	0.35 (0.014)
	125-400	184 (7.2)	0.35 (0.014)
	200-254	242 (9.5)	0.4 (0.016)
	50-380	124 (4.9)	0.35 (0.014)
	65-400	138 (5.4)	0.35 (0.014)
	80-400	169 (6.7)	0.35 (0.014)
	150-315	225 (8.9)	0.4 (0.016)
	150-404	225 (8.9)	0.4 (0.016)
	200-250	235 (9.3)	0.4 (0.016)
	200-319	256 (10.1)	0.4 (0.016)
	200-404	256 (10.1)	0.4 (0.016)
	250-319	300 (11.8)	0.4 (0.016)

**Note:** Gaps apply approximately for wear rings in all materials and in assembled condition.

## 6.9 Assembly

To assemble the pump consult the sectional drawings.

Ensure threads, gasket and O-ring mating faces are clean. Apply thread sealant to non-face sealing pipe thread fittings.

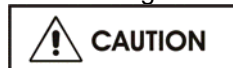

After complete assembly the rotor must be lifted!, see section 5.3 *Impeller clearance*

### 6.9.1 Assembly

Start assembling the upper part.

- Slide the upper intermediate pipe [1341.1] into the support plate and fix it, by mounting the motor stool [3160] and bearing lantern [3140].



- Item [3140] is only provided with rigid coupling arrangement.
- Proceed with reverse disassembly procedure, starting with point 7 to 1.

After finishing the upper part proceed with the lower part, starting with point 16.

## 7.0 AUXILIARIES



For additional accessories refer to separate Instrumentation manuals.

### 7.1 Seal and seal systems

By ECPJ pumps the inner seal is not exposed to the fluid. Therefore only seal systems are used, which require no flushing of the inner seal.

#### 7.1.1 Dual Mechanical Seal unpressurized with API-Plan 11+52+61



Refer to mechanical seal drawing and auxiliary piping drawing.

The pump is equipped with a dual mechanical seal. The cartridge design allows to change the mechanical seal without taking it apart.



Try to turn the rotor by hand. If the rotor cannot be turned readjust it following procedure in section 5.3.1 *Adjusting of the rotor*.

The mechanical seal requires no adjustment anymore. Check if the mounting plates are already swung out.

Actions after start up:

Check all connections to the seal gland and the mechanical seal itself against leakage. Check the temperature of the seal gland. A slight increase of temperature may be observed during the run in period.

The faces of the inner mechanical seal are flushed by the product (API Plan 11). In Plan 11, product is routed from the pump discharge via an orifice to the seal chamber to provide cooling for the seal and to vent air or vapors from the seal chamber. Fluid then flows from the seal cavity back into the process stream. Between the inner mechanical seal and the outer (atmospheric) mechanical seal is a liquid buffer fluid, which is unpressurized (API Plan 52). The buffer fluid is contained in a seal pot (refer to drawing of the seal pot), which is vented to a vent system, thus maintaining the buffer fluid pressure close to atmospheric.

Inner seal leakage will be product leakage into the buffer fluid. There will always be some leakage (max.5 ml/hour).

Plan 52 is used for flashing liquids, which have a vapour pressure higher than the buffer fluid pressure. So the product will flash in the seal pot and the vapour can escape to the vent system.

All screw / flange connections have to be proofed. Straight screw joints made of stainless steel have to be tightened especially carefully.

**CAUTION** Fill the seal system with a suitable buffer fluid (refer to lubrication table).

**CAUTION** Ensure that the valve GV for the connection V is open (Barrier/buffer fluid vessel drawing).

**CAUTION** Open the Block & Bleed valve to allow proper function of the PSH (set point 0.5 bar (7.25 psi) above flare pressure).

**CAUTION** Open all necessary valves in the cooling and auxiliary piping and check the flow. API Plan 61 has tapped and plugged connections for the purchaser's use. Typically this plan is used when the purchaser is to provide fluid (such as steam, gas, or water) to an external sealing device.

**CAUTION** Refer to the GA - drawing for the required quench medium, pressure and flow.

**CAUTION** Disassembly of the seal cartridge is only allowed by authorized personal. Contact Flowserve for any service of the mechanical seal. We recommend to have a spare cartridge seal on stock for easy replacement.

## 7.2 Changing of mechanical seal

### 7.2.1 Changing of mechanical seal with rigid spacer type coupling

1) If the pump is mounted on a tank, ensure that

explosive or toxic gases are drained completely. By pumping explosive or toxic media, flush the tank with Nitrogen.

2) Secure the mechanical seal by putting the mounting plates into the groove of the shaft sleeve [2450]. Loose the clamping ring [2544], and disconnect the seal piping.

**CAUTION** Drain the seal system, if applicable.

3) Loose the socket head cap screw [6579.1] and slip down the rotor by turning the shaft nut [2910]. Open the socket head cap screw [6579.3] at the top shaft [2130.2] and [2130.1]. Push up the top shaft [2130.2] and remove the intermediate coupling [7021]. To pull off the coupling hub, open the socket head cap screw [6579.4] and remove the retaining rings [2530].

**Note:** Take care of the clamping ring [2542].

4) Loose the studs [6572.2] and pull off the mechanical seal cartridge.

5) For assembly follow the reverse procedure.

### 7.2.2. Changing of mechanical seal without rigid spacer type coupling

1) If the pump is mounted on a tank, ensure that explosive or toxic gases are drained completely. By pumping explosive or toxic media, flush the tank with Nitrogen.

2) Pull off the coupling hub from the pump shaft [2110] and take out the key [6700.1].

3) Secure the mechanical seal by putting the mounting plates [9310] into the groove of the shaft sleeve [2450]. Loose the clamping ring [2544], and disconnect the seal piping.

**CAUTION** Drain the seal system, if applicable.

4) Drain the oil from the bearing housing using the plug [6569]. Loose the bolts [6577.10] and pull out the pump from its pit or tank.

5) Loose the socket head cap screw [6579.1] and slip down the rotor by turning the shaft nut [2910] and remove it. Take off the labyrinth ring [4330.1].

**Note:** If applicable pull off the fan [8161.2] after loosening the socket set screw [6577.11].

6) Loose the studs [6572.1], take off the bearing cover [3260.1] and remove the key [6700.2].

Pull off the motor stool [3160]. Loose the studs [6572.2] and pull off the mechanical seal cartridge.

7) For assembly follow reverse procedure.

**Note:** Adjust the rotor axially according to section 5.3 *Impeller clearance*.

## 8.0 FAULTS; CAUSES AND REMEDIES

### FAULT SYMPTOM

Pump overheats and seizes									
↓	Bearings have short life								
	↓	Pump vibrates or is noisy							
		↓	Mechanical seal has short life						
			↓	Mechanical seal leaks excessively					
				↓	Pump requires excessive power				
					↓	Pump loses prime after starting			
						↓	Insufficient pressure developed		
							↓	Insufficient capacity delivered	
								↓	Pump does not deliver liquid
								↓	<b>PROBABLE CAUSES</b>
									<b>POSSIBLE REMEDIES</b>
									<b>A. SYSTEM TROUBLES</b>
●									● Pump not primed. Check complete filling
	●			●	●				● Pump or suction pipe not completely filled with liquid. Check and complete filling
●	●			●	●				● Suction lift too high or level too low. Check NPSHa>NPSHr, proper submergence, losses at strainers / fittings
				●	●	●			● Excessive amount of air or gas in liquid. Check and purge from pipes
				●	●	●			● Air or vapour pocket in suction line. Check suction line design for pockets
				●	●				● Air leaks into suction line. Check airtight pipe then joints and gaskets
				●	●				● Air leaks into pump through mechanical seal, sleeve joints, casing joint or pipe lugs. Check airtight assembly then joints and gaskets
	●				●				● Foot valve too small. Investigate replacing the foot valve
	●				●				● Foot valve partially clogged. Clean foot valve
	●			●	●	●			● Inlet of suction pipe insufficiently submerged. Check cut out system design
					●	●	●		● Total head of system higher than differential head of pump. Check discharge head and head losses in discharge pipe at the valve settings. Check back pressure is not too high
				●					● Total head of system lower than pump design head. Throttle at discharge valve or ask Flowserve if the impeller can be trimmed
				●					● Specific gravity of liquid different from design. Consult Flowserve
				●	●	●			● Viscosity of liquid differs from that for which designed. Consult Flowserve
●	●								● Operation at very low capacity. Measure value and check minimum permitted
	●	●		●					● Operation at high capacity. Measure value and check maximum permitted
									<b>B. MECHANICAL TROUBLES</b>
●	●	●	●	●	●				● Misalignment due to pipe strain. Check the flange connections and eliminate strains using elastic couplings or a method permitted
		●							● Improperly designed foundation. Check setting of baseplate: tighten, adjust, grout base as required
	●	●	●	●	●				● Shaft bent. Check shaft runouts within acceptable values
●	●	●		●					● Rotating part rubbing on stationary part internally. Check for signs of this and consult Flowserve if necessary
●	●	●	●	●					● Bearings worn. Replace bearings
				●	●	●			● Wearing ring surfaces worn. Replace worn wear ring/ surfaces
		●				●	●		● Impeller damaged or eroded. Replace impeller and check reason
				●					● Leakage under sleeve due to joint failure. Replace joint and check for damage
		●	●	●					● Mechanical seal improperly installed. Check alignment of faces or damaged parts and assembly method used

**FAULT SYMPTOM**

<b>Pump overheats and seizes</b>															
↓	<b>Bearings have short life</b>														
	↓	<b>Pump vibrates or is noisy</b>													
		↓	<b>Mechanical seal has short life</b>												
			↓	<b>Mechanical seal leaks excessively</b>											
				↓	<b>Pump requires excessive power</b>										
					↓	<b>Pump loses prime after starting</b>									
						↓	<b>Insufficient pressure developed</b>								
							↓	<b>Insufficient capacity delivered</b>							
								↓	<b>Pump does not deliver liquid</b>						
									↓	<b>PROBABLE CAUSES</b>				<b>POSSIBLE REMEDIES</b>	
				●	●	●							Incorrect type of mechanical seal for operating conditions.	Consult Flowserve	
●	●	●	●	●									Shaft running off centre because of worn bearings or misalignment.	Check misalignment and correct if necessary. If alignment satisfactory check bearings for excessive wear	
●	●	●	●	●									Impeller out of balance resulting in vibration.	Check and consult Flowserve	
			●	●	●								Abrasive solids in liquid pumped.	Check and consult Flowserve	
			●	●									Mechanical seal was run dry.	Check mechanical seal condition and source of dry running and repair	
			●	●									Internal misalignment due to improper repairs causing impeller to rub.	Check method of assembly, possible damage or state of cleanliness during assembly	
●	●	●											Excessive thrust caused by a mechanical failure inside the pump.	Check wear condition of Impeller, its clearances and liquid passages	
	●	●											Excessive grease in ball bearings.	Check method of regreasing	
	●	●											Lack of lubrication for bearings.	Check hours run since last change of lubricant, the schedule and its basis	
	●	●											Improper installation of bearings	Check method of assembly, possible damage or state of cleanliness during assembly and type of bearing used	
	●	●											Damaged bearings due to contamination.	Check contamination source and replace damaged bearings	
													<b>C. ELECTRICAL TROUBLES</b>		
		●		●	●	●							Wrong direction of rotation.	Reverse 2 phases on motor terminal box	
	●	●						●					Motor running too slow,	Check motor terminal box connections	



## **9.0 CERTIFICATION**

Certificates determined from the contract requirements are provided with these instructions where applicable. Examples are certificates for CE marking, ATEX marking etc. If required, copies of other certificates sent separately to the Purchaser should be obtained from the Purchaser for retention with these User Instructions.

## **10.0 OTHER RELEVANT DOCUMENTATION AND MANUALS**

### **10.1 Supplementary user instructions**

Supplementary instructions determined from the contract requirements for inclusion into user Instructions such as for a driver, instrumentation, controller, sub-driver, seals, sealant system, mounting component etc are included in the Data Book. If further copies of these are required they should be obtained from the supplier for retention with these user instructions.

Where any pre-printed set of user instructions are used, and satisfactory quality can be maintained only by avoiding copying these, they are included at the end of these user instructions such as within a standard clear polymer software protection envelope.

### **10.2 Change notes**

If any changes, agreed with Flowserve, are made to the product after its supply, a record of the details should be maintained with these User Instructions.

### **10.3 Additional sources of information**

*Reference 1:*

NPSH for Rotodynamic Pumps: a reference guide, Europump Guide No. 1, Europump & World Pumps, Elsevier Science, United Kingdom, 1999.

*Reference 2:*

Pump Handbook, 2<sup>nd</sup> edition, Igor J. Karassik et al, McGraw-Hill Inc., New York, 1993.

*Reference 3:*

ANSI/HI 1.1-1.5  
Centrifugal Pumps - Nomenclature, Definitions, Application and Operation.

*Reference 4:*

ANSI B31.3 - Process Piping.

### 10.4 Abbreviations

Quantity	ISO unit	ISO unit abbreviation	Multiplication Factor <sup>1</sup>	US unit	US unit Abbreviation
Area	square metre	m <sup>2</sup>	10.764	square feet	ft <sup>2</sup>
	square centimetre	cm <sup>2</sup>	0.155	square inch	in. <sup>2</sup>
Capacity or Flow rate	Cubic metre/hour	m <sup>3</sup> /h	4.4033	US Gallons/minute	US gpm
Force	Newton	N	0.2248	pound.force	lbf
Head	metre	m	3.28084	feet	ft
Heat Energy	kilojoule	kJ	0.9478	British thermal unit	Btu
Length	metre	m	3.28084	feet	ft
	millimetre	mm	0.03937	inch	in.
	micrometre	µm	0.00003937	inch	in.
Mass	kilogram	kg	2.20462	pounds	lb.
	gram	g	0.035274	ounces	oz.
Moment of Inertia	kilogram square metre	kg.m <sup>2</sup>	23.73	pounds square feet	lb.ft <sup>2</sup>
Noise <sup>4</sup>	decibel	dBA			
Power	kilowatt	kW	1.34102	horsepower	hp
Pressure <sup>2</sup>	bar	bar	14.5	pounds/in. <sup>2</sup>	psi
Rotational Speed	revs per minute	r/min			
Stress	Newton/square millimetre	N/mm <sup>2</sup>	145.0	pounds/in. <sup>2</sup>	psi
Temperature	degrees Celsius	°C	(1.8 x °C) + 32	degrees Fahrenheit	°F
Torque	Newton.metre	Nm	0.7376	pound.feet	lbf.ft
Unbalance	gram millimetre	g.mm	0.001389	ounce-inch	oz-in.
Velocity	metre/second	m/s	3.28084	feet/second	ft/sec
	millimetre/second	mm/s	0.03937	inches/second	in./sec
Vibration <sup>3</sup>	millimetre/second	mm/s	0.03937	inches/second	in./sec
Viscosity	square millimetre/second or centiStoke	cSt			
Volume	cubic metre	m <sup>3</sup>	264.2	US Gallons	US gal.
	cubic centimetre	cm <sup>3</sup>	0.0610237	cubic inch	in. <sup>3</sup>
	litre	l	33.81	fluid ounce	fl. oz.

<sup>1</sup> multiply the ISO unit by the multiplication factor to obtain US units

<sup>2</sup> where pressure is not stated to be absolute it is gauge

<sup>3</sup> where not stated to be peak it is r.m.s.

<sup>4</sup> sound pressure level LpA, re 1m - 20microPa, or sound power level LwA re 1 pW when sound power is applicable

# AFTERMARKET DIRECTORY

## OUR ADDRESS

**Flowserve (Austria) GmbH**  
 Industriestraße B/6  
 A-2345 Brunn/Geb., AUSTRIA

Tel: +43 / 2236 / 31530  
 Fax: +43 / 2236 / 31940  
 Mail: FPD-Brunn@flowserve.com

**IF YOU NEED ANY INFORMATIONS ON PRICES, QUOTATIONS FOR PARTS, FIELD SERVICE, REPAIRS... PLEASE CONTACT DIRECTLY OUR SPECIALISTS BY DIALING OUR PHONE NUMBER AND HIS EXTENSION**

<b>MANAGER</b>
<b>PARTS QUOTATIONS</b>
<b>PARTS ORDER HANDLING</b>
<b>FIELD SERVICE / REPAIRS</b>
<b>SECRETARY</b>
<b>EXPORT / INVOICING</b>

EXT. 297
EXT. 236
EXT. 237
EXT. 205
EXT. 232
EXT. 238

**MESSAGES CAN BE LEFT ALSO ON OUR ANSWERING MACHINE**

**IMPORTANT NOTES:**

**PLEASE NOTE, THAT WARRANTY EXPIRES:**

- USE OF NON GENUINE FLOWSERVE AUSTRIA PARTS FOR MAINTENANCE AND REPAIRS
- NO USE OF OUR SERVICE PERSONAL IN CASE OF REPAIRS DURING WARRANTY PERIOD

**RECOMMENDATION:**

- STARTUP AND COMMISSION SERVICE DIAL: EXT 205
- PLEASE ASK FOR OUR SPECIAL RATES
- PLEASE ALSO ASK OUR SERVICE PERSONAL ABOUT REPAIRING AND SERVICING YOUR PUMPS AFTER THE WARRANTY PERIOD

## Please quote your service:

Name of Company: .....

Contact person:.....

Telephone: .....

Fax: .....

e-mail: .....

Country: .....

**Pumpdata:**

Type: .....

Serialno.: .....

Customer Service Fax: +43-2236-31940

**Your Flowserve factory contacts:**

Flowserve (Austria) GmbH  
Industriestraße B6  
2345 Brunn am Gebirge  
Austria

Telefon: +43 2236 31530  
Fax: +43 2236 377 540  
Service & Repair Fax: +43 2236 31582  
E.mail: FPD-Brunn@flowserve.com

**FLOWSERVE REGIONAL  
SALES OFFICES:**

**USA and Canada**

Flowserve Corporation  
5215 North O'Connor Blvd.,  
Suite 2300  
Irving, Texas 75039-5421 USA  
Telephone 1 972 443 6500  
Fax 1 972 443 6800

**Europe, Middle East, Africa**

Worthing S.P.A.  
Flowserve Corporation  
Via Rossini 90/92  
20033 Desio (Milan) Italy  
Telephone 39 0362 6121  
Fax 39 0362 303396

**Latin America and Caribbean**

Flowserve Corporation  
6840 Wynnwood Lane  
Houston, Texas 77008 USA  
Telephone 1 713 803 4434  
Fax 1 713 803 4497

**Asia Pacific**

Flowserve Pte. Ltd  
10 Tuas Loop  
Singapore 637345 Singapore  
Telephone 65 67710600  
Fax 65 6779 4607